

Single-phase Microinverter

USER MANUAL

HMS-600W-2T
HMS-700W-2T
HMS-800W-2T
HMS-900W-2T
HMS-1000W-2T

Legal Notice

Hoymiles has made every effort to ensure the accuracy and completeness of this manual. However, the content of this manual is continually reviewed and amended, due to product enhancements or feedback from real-world usage.

Hoymiles retains the right to modify this manual without prior notice at any time. Please refer to Hoymiles' official website at www.hoymiles.com or scan the QR code for the latest version.



Emission Compliance

This equipment has been tested and found to comply with the limits applied by the local regulations. These limits are designed to provide reasonable protection against harmful interference in a residential installation. This equipment generates, uses, and can radiate radio frequency energy and, if not installed and used in accordance with the instructions, may cause harmful interference to radio communications. However, there is no guarantee that interference will not occur in a particular installation. If this equipment does cause harmful interference to radio or television reception, which can be determined by turning the equipment off and on, you are encouraged to try to correct the interference by one or more of the following measures:

- Reorient or relocate the receiving antenna.
- Increase the separation between the equipment and the receiver.
- Connect the equipment into an outlet on a circuit different from that to which the receiver is connected.
- Consult the dealer or an experienced radio/TV technician for help.

Changes or modifications not expressly approved by the party responsible for compliance may void the user's authority to operate the equipment.

Warranty

To ensure reliability and warranty compliance, follow the installation instructions in this manual. You can access the current warranty conditions at www.hoymiles.com.

Contact Information

If you have technical queries or any questions concerning Hoymiles products, please contact us:



Floor 6, Building 5, Housheng 99 Road, Gongshu District, Hangzhou 310015 P. R. China



Germany: service.de@hoymiles.com France: service.fr@hoymiles.com

Spain: service.es@hoymiles.com Netherlands: service.nl@hoymiles.com

Italy: service.it@hoymiles.com Rest of the EU: service.eg@hoymiles.com



+ 31 852736388 (Supports English, German, and Dutch)



hoymiles.com

Using This Manual

Symbols

Symbol

•	List
Step 1, Step 2. ...	Installation steps in a defined order

Related Documents

The following documents have been produced to assist you in maximizing the microinverter's potential.

Datasheet	Datasheet HMS-1000W Series EU EN
Quick Installation Guide	Quick Installation Guide HMS-1000W Series EU EN
Tutorial Videos	Installation Video HMS-1000W Series Global EN
Others	Hoymiles Compatibility Calculator

Download the Application

Download and install the **S-Miles Installer** application before use.



Revision History

Issues 01 (2023-07)

V1.0	2023-07-15	This issue marks the initial official release.
------	------------	--

CONTENTS

1. About This Manual	1
1.1 Purpose	1
1.2 Audience	1
1.3 Validity	1
2. Safety Instructions	2
2.1 Safety Symbols	2
2.2 Safety Instructions	2
3. Product Information	5
3.1 Overview	5
3.2 Appearance and Dimensions	8
3.3 Symbols on the Product	9
4. Installation Steps	10
4.1 Preparation	10
4.2 Mechanical Installation	13
4.3 AC Side Electrical Installation	15
4.4 DC Side Electrical Installation	21
4.5 Start-Up	22
5. Setting Up and Activating Monitoring	23
5.1 Direct Connection	23
5.2 Remote Connection	25
6. Troubleshooting	28
6.1 Troubleshooting List	28
6.2 LED Indicator Status	31
6.3 AP Password Troubleshooting	31
6.4 Wireless Network Troubleshooting	32
6.5 On-Site Instruction (for qualified installers only)	33
7. Decommission	34
7.1 Removing the Microinverter	34
7.2 Replacing the Microinverter	34
7.3 Storing and Transporting the Microinverter	35
7.4 Disposing of the Microinverter	35
8. Technical Data	36
9. Appendix 1: Installation Map	37
10. Appendix 2: WIRING DIAGRAM - 230VAC SINGLE PHASE:	38
11. Appendix 3: Checklist	39
12. Appendix 4: Terms and Abbreviations	39

1. About This Manual

1.1 Purpose

This document provides detailed instructions on installation, electrical connection, commissioning, maintenance and troubleshooting of HMS-1000W series microinverters.

Before installing and operating the microinverter, consider the following points:

- Read this document carefully before operation.
- Keep this document for reference.

1.2 Audience

This document is only applicable to qualified personnel who possess the following skills:

- Understanding of microinverter operation and functionality
- Competence in handling microinverter installation, repair, and usage risks
- Proficiency in microinverter installation and commissioning
- Familiarity with local electrical codes, and regulations
- Adherence to this document and all safety guidelines

1.3 Validity

This document is valid for:

Model Number	Output Power (W)
HMS-600W-2T	600
HMS-700W-2T	700
HMS-800W-2T	800
HMS-900W-2T	900
HMS-1000W-2T	1000



Notice: Model identifier

HMS-1000W-2T



A B C D

No.	Meaning	Remark
A	Series Name	-
B	Output Power Level	-
C	Feature	Built-in Wi-Fi Module
D	Number of Inputs	Two Inputs

2. Safety Instructions

2.1 Safety Symbols

Safety symbols are used in this manual as follows:

Symbol	Description
	This symbol indicates a hazardous situation that can result in high-level electric shocks or other serious physical injuries.
	This symbol indicates that directions must be strictly followed to avoid safety hazards, including equipment damage and personal injury.
	This symbol indicates a forbidden action. You should stop, exercise caution, and fully understand the operations explained before proceeding.

2.2 Safety Instructions

The HMS-600W/700W/800W/900W/1000W-2T microinverter has been designed and tested in accordance with international safety requirements, but it still requires careful installation and operation.

Installers must carefully read and strictly follow the safety instructions provided in this section. Failure to do so may result in:

- injury or death to the installer or operator
- damage to the microinverter



Danger!

General

- Be extremely careful when the microinverter has been disconnected from the public grid. Hazardous voltage remains present in some components.

Installation

- Avoid installing the equipment in flammable, explosive, corrosive, extremely hot/cold, and humid environments.
- Prior to handling any part of the microinverter, ensure that the surface and the entire equipment are within the limits of safe temperature and voltage potential.
- Each input of the microinverter should be exclusively connected to one PV module. Do not connect batteries or any other power supply sources.
- Use personal protective equipment, including gloves and goggles, during installation.
- Notify the manufacturer about any non-standard installation conditions.
- Electrical installation and maintenance must be performed by a licensed electrician, following local wiring regulations.
- Avoid using the equipment in environments where safety devices are not functioning properly.
- Refrain from using the equipment if any operating anomalies are detected.
- Only use the microinverter when all technical parameters are observed and applied correctly.
- Hoymiles holds no liability for any damage resulting from incorrect or improper operation.

Maintenance & Repair

- All repairs must be done with qualified spare parts which must be installed in accordance with their intended use and by a licensed contractor or authorized Hoymiles service representative.



Warning!

General

- The microinverter must be disconnected from the electrical power supply before any connections with the device are established or in any way altered.
- Make sure that the product is not accessible to unauthorized persons.
- All operations including transportation, installation, start-up and maintenance must only be carried out by qualified and trained personnel.

Installation

- Wear proper personal protective equipment when working on the product, especially when handling hazardous substances.
- Comply with local and national standards for all electrical connections at the installation site.
- Install the microinverter below the PV module to protect it from rain, UV, and adverse weather.
- Do not expose the AC and DC connectors to rain or moisture until connected.
- Obtain necessary approvals from the local power operator before connecting the microinverter to the power grid.
- Check that the PV module's maximum open circuit voltage is within the specified limit for the microinverter.
- Verify electrical compatibility of PV modules using the Hoymiles Compatibility Calculator at <https://www.hoymiles.com/resources/microinverter-calculator/>.
- Disconnect the microinverter from all power sources before performing any work.
- Before installation, check for transportation damage that could compromise insulation integrity and safety clearances.

Operation

- Use only Hoymiles microinverters with compatible PV modules as indicated by the Hoymiles Compatibility Calculator to maintain the Hoymiles warranty.
- Unauthorized removal of necessary protections, improper use, incorrect installation, and operation may cause damage to the equipment or incur serious safety and shock hazards.
- During operation and for a short time after switching off the AC circuit breaker, the surfaces of the microinverter can reach a high temperature. Avoid coming into direct contact with these surfaces.
- Hoymiles is not liable for any damage caused by incorrect or improper operation.

Maintenance & Repair

- Disconnect the power supply before any maintenance and repair operation.
- Repairs on equipment may only be carried out by Hoymiles Service Team, by a repair team authorized by Hoymiles, or by authorized personnel who are thoroughly acquainted with all the warnings and operating procedures contained in this manual.



CAUTION!

Installation

- Each branch should have a circuit breaker. The central protection unit is unnecessary.
- Securely mount the microinverters using appropriate mounting torque. Ensure stability and proper alignment.
- Follow the safety instructions for electrical connections, ensuring proper polarity and secure connections.

Operation

- Check the microinverter system after installation to ensure proper functioning and performance. Verify the electrical connections, communication links, and monitoring capabilities.

Maintenance & Repair

- Maintenance must be carried out with the equipment disconnected from the grid (power switch open) and the PV modules shaded or isolated unless otherwise indicated.
- The packaging of the microinverter has been specially designed and is reusable. Retain the packaging for future use.
- Do not attempt to repair the product. All repairs should be done using only eligible spare parts.
- Do not clean the equipment with rags made of filamentary or corrosive materials to avoid corrosion and electrostatic charges.

3. Product Information

3.1 Overview

Functions

Hoymiles HMS-1000W series microinverters are single-phase units designed for module-level operation. They convert DC power generated by PV modules into AC power, and feed the electricity into the power grid.

Harnessing the power of two independent MPPT technologies, the HMS-1000W series microinverters maximize energy yield while ensuring system reliability.

Ideal for mini PV systems like balconies, the HMS-1000W series microinverters come equipped with an integrated industrial+ grade Wi-Fi module. The user-friendly HMS Cable System makes installation effortless, eliminating the need for complex wiring.

Features

- Plug-and-play design for mini PV systems
- Built-in industrial+ grade Wi-Fi module for high reliability
- Compatible with Micro Toolkit or S-Miles Cloud for monitoring and management
- Output power setting function to customize performance
- Enhanced safety with rapid shutdown compliance and isolated transformer
- High-powered microinverter with up to 1000 VA output

Applications

The HMS-1000W series can be used in both single-microinverter and multi-microinverter systems.

- A single-microinverter system is a solar power setup with one microinverter and two PV modules, designed for installation on a balcony or an outdoor area*.

In a single-microinverter system, you can connect the entire setup to the AC grid using the HMS Plug and Play Cable or the HMS Field Connector**.

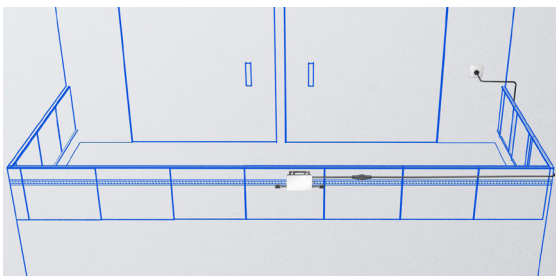

Figure 1-1 Balcony - Single-Microinverter System

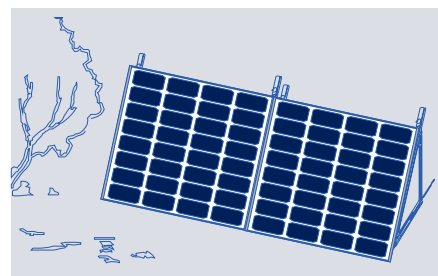

Figure 1-2 Outdoor Area - Single-Microinverter System



Notice:

*: Outdoor Area refers to areas with sufficient sunlight (gardens, yards, or any other open-air environments).

**.: HMS Plug and Play Cables and HMS Field Connector are designed for the situation where a PV system only has one microinverter.

HMS Field Connector

HMS Field Connector provides a quick and simple electrical connection between the microinverter and the grid by serving as a joining component.



HMS Plug and Play Cable

The Plug and Play Cable consists of the HMS field connector, AC cable, and plug. The HMS field connector is connected to the microinverter, and the plug is connected to the household socket in accordance with local regulations.



- A multi-microinverter system consists of multiple microinverters, each microinverter is paired with two PV modules, providing independent operation and optimized performance. In a multi-microinverter system, you require the HMS Cable System^{***}, an AC end cable, and a distribution box to link the microinverters to the AC grid.

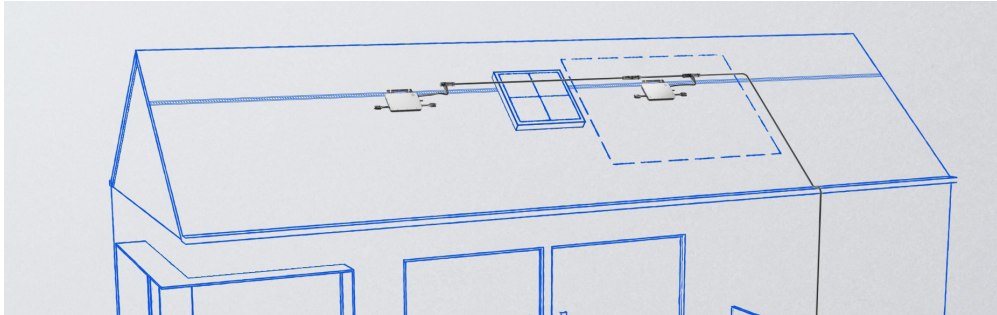

Figure 1-3 Rooftop - Multi-Microinverter System







For a multi-microinverter system, you need to prepare the following components:

- PV modules
- Microinverters
- HMS Cable System
- AC cable
- Distribution Box



Notice:

****: The HMS Cable System is suitable for connecting multiple microinverters in a multi-microinverter system. HMS Cable system consists of the following components:*

<p>HMS Connection Cable</p> <p>Make a customized AC Trunk by utilizing HMS Trunk Connectors and HMS Extension Connectors.</p> 	<p>HMS Trunk Connector</p> <p>Used to connect the microinverter's AC output to the AC Trunk, as well as to join together multiple HMS Connection Cables to create the AC Trunk.</p> 
<p>HMS Connector</p> <p>Used to form the AC cable into an AC End Cable, which completes the connection between the end of the AC Trunk and the distribution box.</p> 	<p>HMS Extension Connector</p> <p>Used to extend your cable runs when the distance between two microinverters exceeds the standard length of an HMS Connection Cable.</p> 
<p>HMS Sealing Cap</p> <p>Used to cover the unused connection port on the HMS Trunk Connector, which is typically located at the beginning of the AC Trunk.</p> 	<p>HMS Disconnect Tool</p> <p>A versatile tool that can be used to take apart connectors, tighten nuts, and loosen nuts.</p> 

Communication Diagram

The HMS-1000W series microinverters provide two convenient methods to access production data, view performance, and adjust parameters.

Direct connection: Utilizing your smartphone or tablet, you can connect directly to the microinverter’s hotspot. This allows you to access local data stored within the microinverter without the requirement of registering an account or creating an online power plant.

Remote connection: By connecting the microinverter to the S-Miles Cloud platform via a router and scanning the microinverter’s serial number, you can access production data and benefit from remote monitoring capabilities.

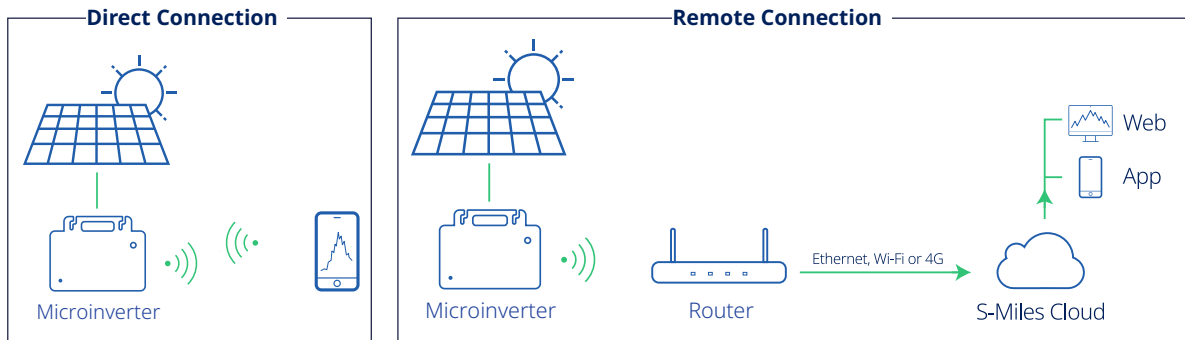

Figure 1-4 Wiring Diagram

How the HMS-1000W Series Microinverters Work

A typical HMS-1000W series microinverter system consists of HMS-1000W microinverters and the Hoymiles monitoring platform, S-Miles Cloud.

The HMS-1000W series microinverters convert direct current to alternating current and transmit module-level data to the S-Miles Cloud.

The S-Miles Cloud is a comprehensive monitoring and analysis platform that provides real-time insights into solar system performance. It enables remote monitoring, module-level monitoring, and efficient operations and maintenance (O&M).

Once the HMS-1000W microinverters are installed and connected to the S-Miles Cloud via an internet connection, they will automatically transmit data. The S-Miles Cloud platform offers real-time and historical insights into your solar system’s performance, allowing you to track trends and stay updated on your PV system’s status.

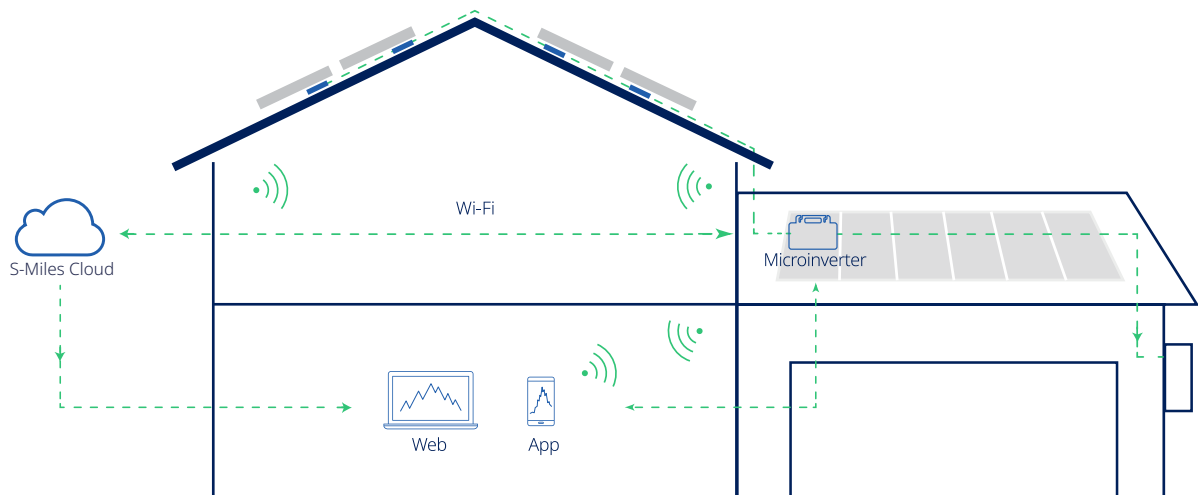

Figure 1-5 HMS-1000W Series Microinverters System Diagram

Supported Grid Type

The HMS-1000W series microinverters support the following power grid type.

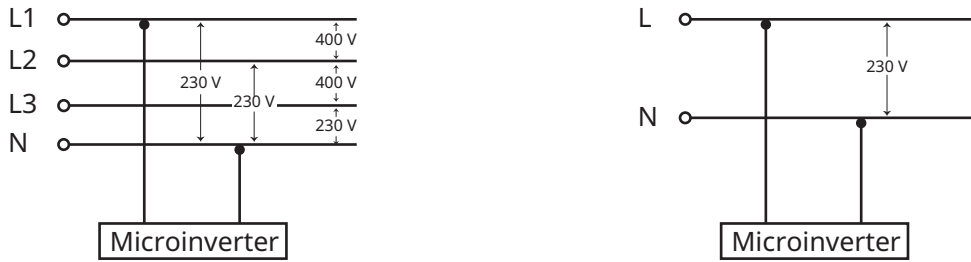
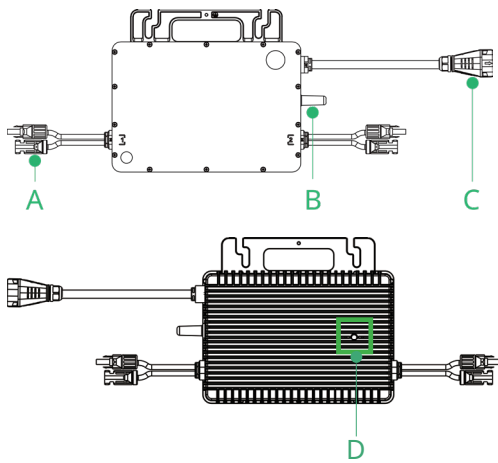

Figure 1-6 Supported Grid tType

3.2 Appearance and Dimensions

Appearance



Item	Description
A	DC Connectors
B	Wi-Fi Antenna
C	AC Connectors
D	LED Light

Notice: The appearance shown here is for reference only. The actual product you receive may differ.



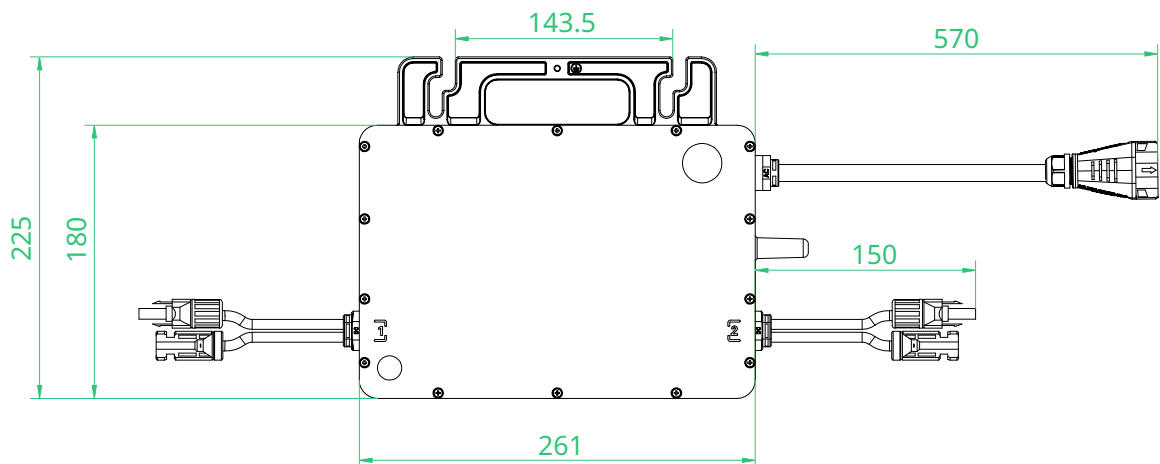

Dimensions (mm)

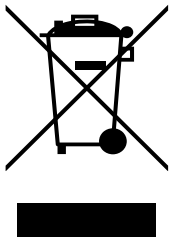

Notice: The dimensions shown here are for reference only. The actual product you receive may differ.

3.3 Symbols on the Product

The following symbols appear on the product label and are described here:

Icon	Explanation
	<p>Treatment</p> <p>To comply with European Directive 2002/96/EC on Waste Electrical and Electronic Equipment and its implementation as national law, electrical equipment that has reached the end of its life must be collected separately and returned to an approved recycling facility. Any device no longer needed must be returned to an authorized dealer or approved collection and recycling facility.</p>
	<p>Caution</p> <p>Risk of electrical shock.</p>
	<p>High Voltage</p> <p>High voltage in the microinverter can cause dangers to life.</p>
	<p>Hot Surface</p> <p>During operation, the microinverter may become hot. Avoid contact with metal surfaces.</p>
	<p>CE mark</p> <p>The microinverter conforms to the Low Voltage Directive for the European Union.</p>
	<p>Read manual first</p> <p>Read this manual carefully before performing installation, operation and maintenance.</p>

4. Installation Steps

4.1 Preparation

Unpacking the Box

The microinverter is thoroughly tested and strictly inspected before delivery. But, damage may still occur during shipping.

After unpacking the microinverter, conduct a thorough inspection:

- Check for any external damage
- Check and confirm that all items are present

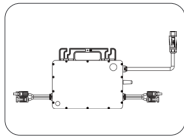

Microinverter

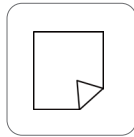

Guide & Map



Notice: Contact your supplier or distributor immediately if there are any damages or missing parts.

Checking the Parts

Single-Microinverter System

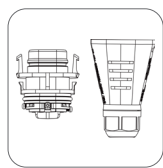

HMS Field Connector

+

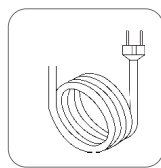

AC Cable

or

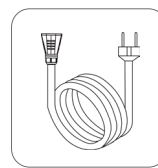

Plug and Play Cable



Notice: The SCHUKO plug is a common grid connection in Europe for the microinverter to the socket. Alternatively, you have the flexibility to choose a plug that adheres to the local grid regulations for your microinverter system's grid connection.

Multi-Microinverter System

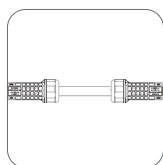
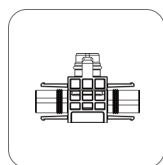
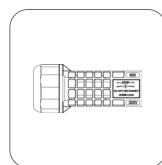
HMS Connection
CableHMS Trunk
Connector

HMS Connector

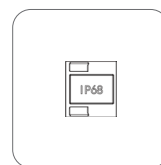

HMS Sealing Cap

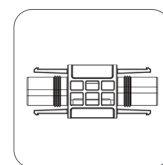
HMS Extension
Connector

AC cable

Checking the Tools

Installation tools include but are not limited to the following recommended ones. If necessary, use other auxiliary tools on site.

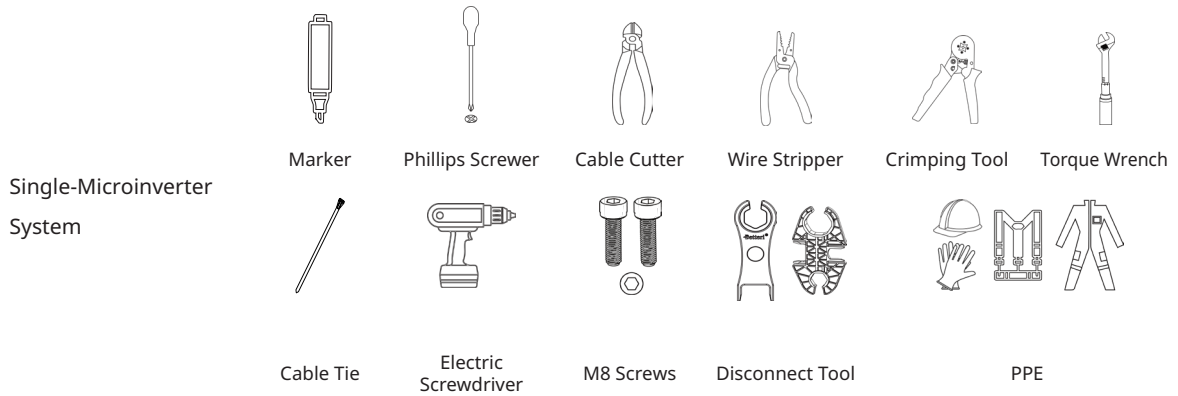

Checking the Tools

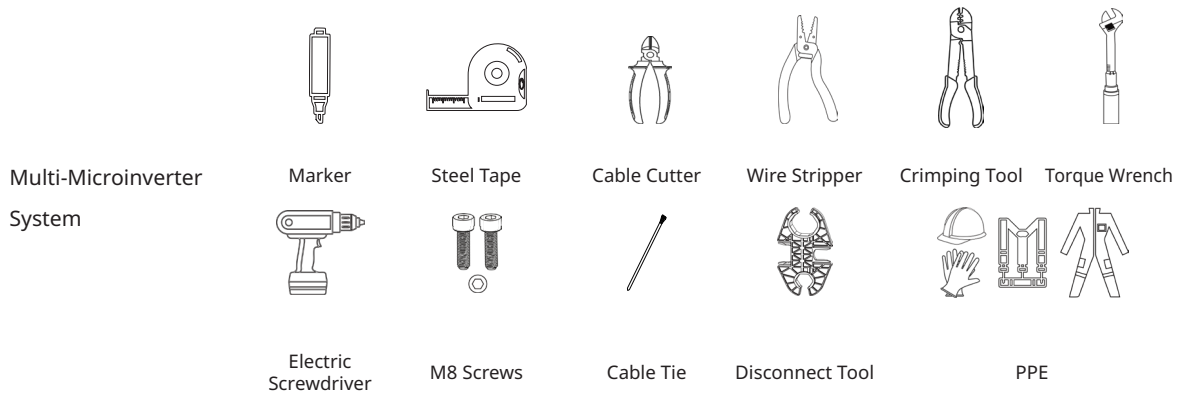

Notice: Tools Specification.

Item	Specification
Crimping Tool	Crimp range: 2.5 mm, 4 mm, and 6 mm
Electric Screwdriver	Including the torque range from 2-9 N•m
Torque Wrench	Including the torque range from 1.5-3 N•m

Downloading the Application

Download the S-Miles Installer application. To download,

- Scan the QR code located on the right side.
- Search for “S-Miles Cloud Installer” on App Store or Google Play.



Planning the Microinverters

For a single-microinverter system, the entire system consists of **ONE** microinverter and **TWO** PV modules.

For a multi-microinverter system, you should define the number of microinverters per AC output line based on the capacity of the AC cables.

Multi-Microinverter System—Maximum Microinverter Number per Line (230 V)					
Model	HMS-600W-2T	HMS-700W-2T	HMS-800W-2T	HMS-900W-2T	HMS-1000W-2T
2.5 mm ²	9	7	6	6	5



Notice:

- AC cable ampacity determines the limits, which may vary. Check local codes to define the actual limitations. You can also refer to [Hoymiles Technical Note](#).
- Multiple 1-in-1, 2-in-1, and 4-in-1 microinverters can be connected to the same AC output line, as long as the total current does not exceed local regulations' ampacity limit.

Determining the Installation Position

The following criteria are important to ensure the best location for the microinverter:

IP 67

- The microinverter meets the IP67 rating for environmental protection and can be installed indoors or outdoors.



- Shield the microinverter and DC connections from sunlight, rain, snow, UV, and other elements by installing them beneath the PV module.



- Install the microinverter beneath the PV modules to prevent power derating caused by temperature rise.



- Provide a minimum clearance of 2 cm around the microinverter enclosure to ensure proper ventilation and heat dissipation.
- Align environmental conditions with microinverter requirements specified in the [Technical Data](#) section, including the protection level, temperature, humidity, altitude, and more.



- Do not install the microinverter in:
 - Areas near corrosive, flammable, or explosive materials.
 - Areas accessible to children or pets.

Selecting the AC Cables

Select the AC cables according to the local regulations and the following guidelines:

Type	Wire Type	Size	Cross-section Diameter	Maximum Voltage
Single-Microinverter System	Outdoor Use, Copper Wire	1.5 mm ² / 1.0 mm ²	8 - 9.5 mm	-
Multi-Microinverter System	, Copper Wire	2.5 mm ²	≤ 16.5 mm	600 V

4.2 Mechanical Installation

Follow the listed steps to install the microinverters.



- In order to avoid electric shock or other injury, be sure there are no electricity or plumbing installations before drilling holes.*
- Make sure there is no electrical connection before proceeding with the installation.*
- Always install the microinverter beneath the PV module to avoid direct exposure to rain UV, and other harmful weather events.*



For a single-microinverter system, two factors need consideration:

- The handrail should be structurally stable and can support the microinverter's weight.*
- Avoid installing on uneven, slanted, or rough surfaces.*



- Given the complexity of balcony installations, consider handrail stability, handrail weight limitations, appropriate mounting methods, and balcony regulations. Seek professional advice if necessary.*

Single-Microinverter System

Hoymiles offers two options for building a single-microinverter system:

- Field-Connected Plug Configuration:** The second option utilizes a field connection plug. To implement this configuration, prepare an HMS Field Connector and an AC cable with a Schuko Plug. One end of the AC cable connects to the HMS Field Connector, while the other end with the Schuko plug connects to the socket.
- Plug-and-Play Configuration:** In this setup, an HMS Plug and Play Cable connects the microinverter to a socket. One end of the HMS Plug and Play Cable directly connects to the microinverter, while the other end plugs into the socket. This configuration ensures simple and convenient installation without requiring additional stripping and crimping operation.

Assembly Diagram

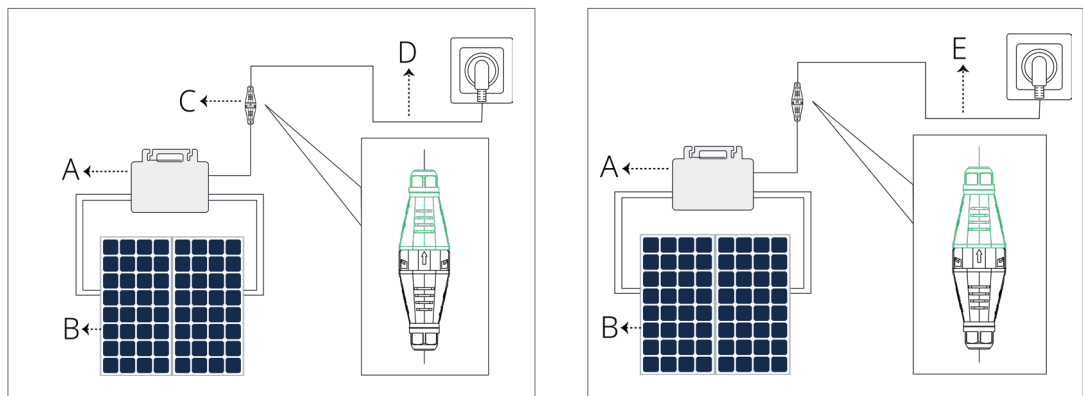

Position	Description	Position	Description
A	Microinverter	D	AC Cable
B	PV modules	E	Plug and Play Cable
C	HMS Filed Connector		

Step 1 Position the Microinverter

- a. Plan and mark the position of the microinverter.
- b. Drill holes with an electrical drill.

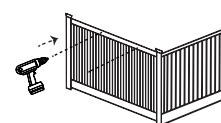
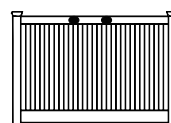

Notice: Single microinverter systems offer flexible installation options, such as balconies, front lawns, or rooftops. Please note that the provided installation steps are for reference only, as the actual process may vary based on specific situations and local regulations.

Step 2 Fix the Microinverter

- a. Mount and align the microinverter (label side up) with the drilling holes.
- b. Fix the microinverter with screws (Torque: 9 N·m).

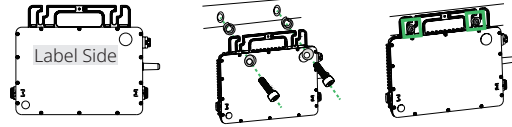

*** Additional Grounding (if necessary)**

The AC cables already include earth wires for direct grounding.
Use the grounding brackets on the right if external grounding is required.

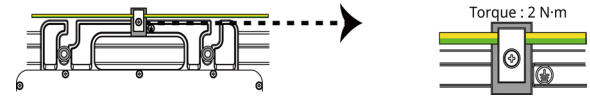

Multi-Microinverter System

Assembly Diagram

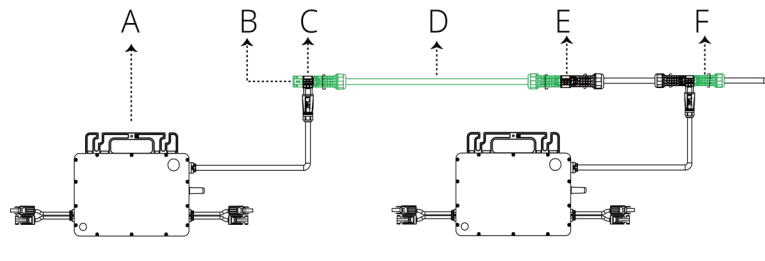

Position	Description
A	Microinverter
B	HMS Sealing Cap
C	HMS Trunk Connector
D	HMS Connection Cable
E	HMS Extension Connector
F	HMS Connector

Step 1 Position the Microinverter

- a. Plan and mark the position of each microinverter on the racking.
- b. Slide all sliding T-nuts along the racking until they are fully seated in the marked locations.

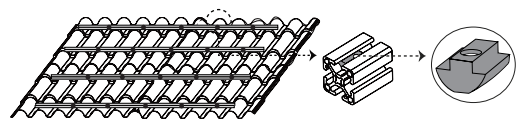

Step 2 Attach the Microinverters to the Racking

- a. Place the microinverter (label side up) onto the racking.
- b. Secure the microinverter to the racking (Torque: 9 N·m).

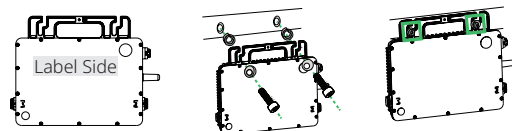

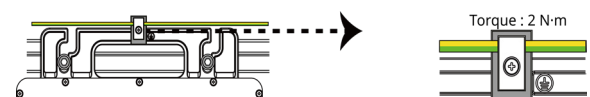

*** Additional Grounding (if necessary)**

The AC cables already include earth wires for direct grounding.
Use the grounding brackets on the right if external grounding is required.



4.3 AC Side Electrical Installation

Follow the listed steps to install the microinverters.

	<ul style="list-style-type: none"> Before starting electrical connections, disconnect AC circuit breakers and prevent them from inadvertent reconnection. Ensure that all cables are voltage free before performing cable connections.
	<ul style="list-style-type: none"> Only qualified personnel can perform cable connection. The operator must wear proper PPE during the process. All cables must be undamaged, properly insulated, firmly attached, and adequately dimensioned. Always install the microinverter beneath the PV module to avoid direct exposure to rain UV, and other harmful weather events. Before installing the PV modules, ensure that all microinverters and inter-wiring connections are properly set up.
	<ul style="list-style-type: none"> All electrical connections must be in accordance with local and national standards. Do not pull or hold the AC cable with your hand. Hold the handle instead. Mounting torque of the M8 screw is 9 N·m. Do not over-torque.

Single-Microinverter System (work with HMS Field Connector)

Step 1 Separate the HMS Field Connector

a. Separate the HMS Field Connector into the connector body, cover, gasket, compression ring, and nut.

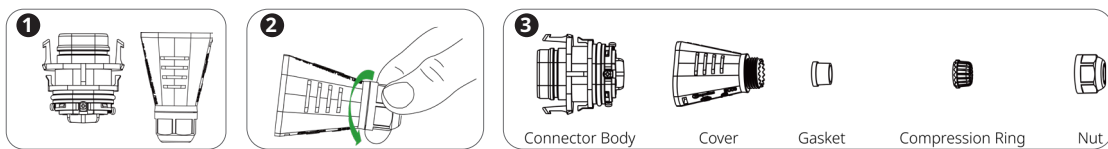

b. Prepare an AC cable.

Wire Type	Guage	Cable Diameter	Remark
Outdoor Use, Copper Wire	1.5 mm ² / 1.0 mm ²	 8 mm to 9.5 mm	with a Schuko Plug

c. Set the parts on the cable according to the order of 1 > 2 > 3 > 4.

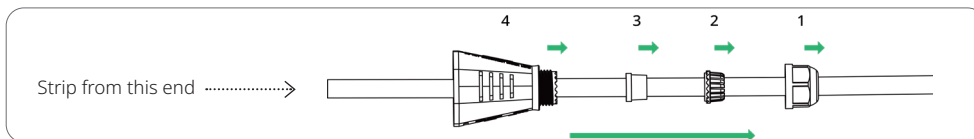

Step 2 Make the AC Cable

a. Strip off 25±3 mm of the outer jacket and strip the conductor insulation to 6±1 mm.

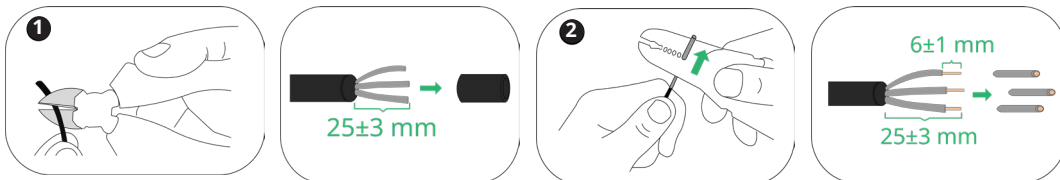

b. Push the stripped wire end into the ferrule through the plastic collar and crimp the bootlace ferrule tightly.

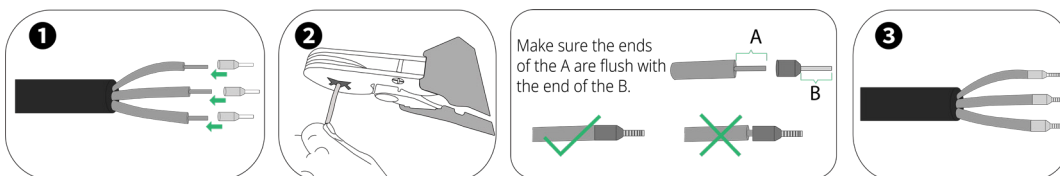

Notice: Make sure the ends of the conductors are flush with the ends of the plastic collar of the bootlace ferrule.

Step 3 Insert the AC Cable

a. Loosen tight screws with a Phillips screwdriver.

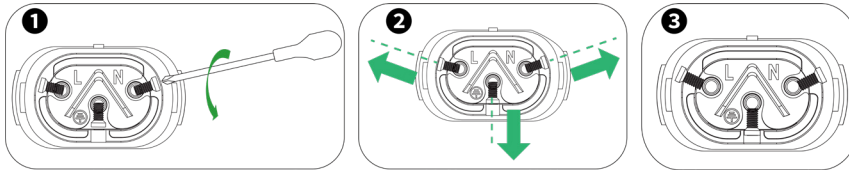

Notice: specification of the screwdriver: M2.

b. Insert the L, N, and PE wires into the connector body in accordance with the labeling.

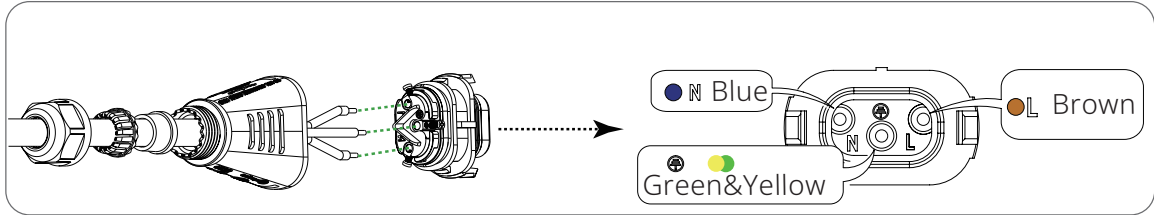

c. Tighten the screws (Torque: 0.2-0.3 N·m).

Step 4 Tighten the Nut

a. Push the cover into the connector body until hearing a locking "click".

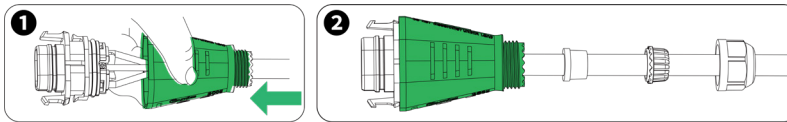

b. Push the gasket, compression ring, and nut according to the order of 1 > 2 > 3.

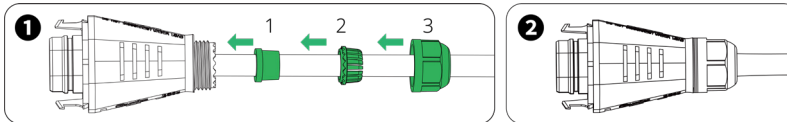

c. Firmly tighten the nut with a torque wrench (Torque: 2 ± 0.5 N·m).

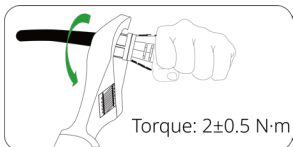

Step 5 Connect the HMS Field Connector to the microinverter

Connect the HMS Field Connector to the output connector of the microinverter until it clicks into place.

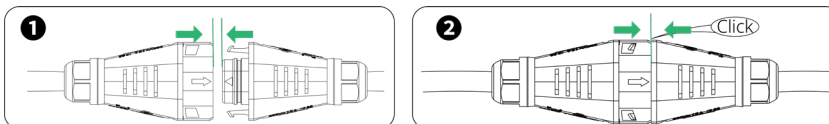

Notice: If you want to disconnect the microinverter from the HMS Field Connector, you should use a Disconnect Tool.

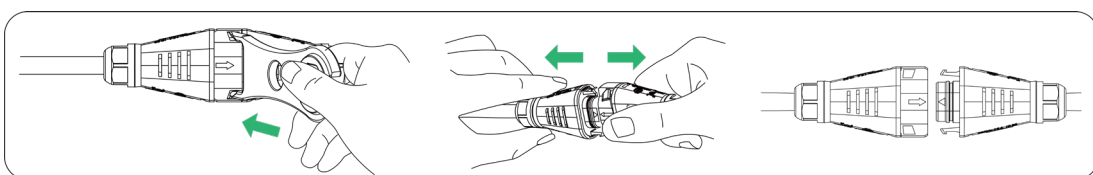

Single-Microinverter System (work with Plug and Play Cable)

Connect the Plug and Play Cable to the microinverter. Listen for a click as they engage.

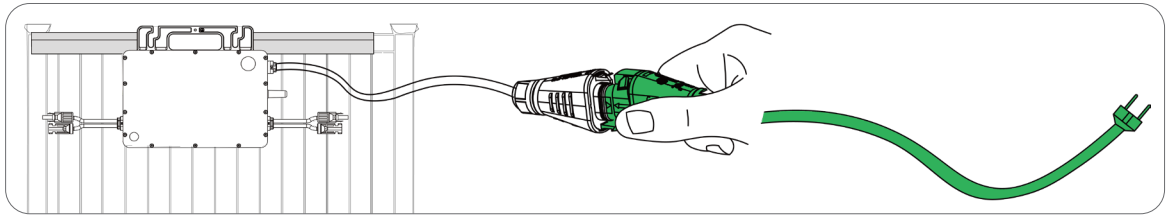

Multi-Microinverter System

In a multi-microinverter system, the focus of the AC side connection is primarily on connecting the AC output lines of the microinverter systems.

The AC output line consists of two main components: the AC Trunk and AC End Cable. The AC Trunk is a series of cables and connectors that belongs to the HMS Cable system, which transmits power from the microinverter to the AC End Cable. The AC End Cable serves to distribute the power to the distribution box.

The system overview has been shown below.

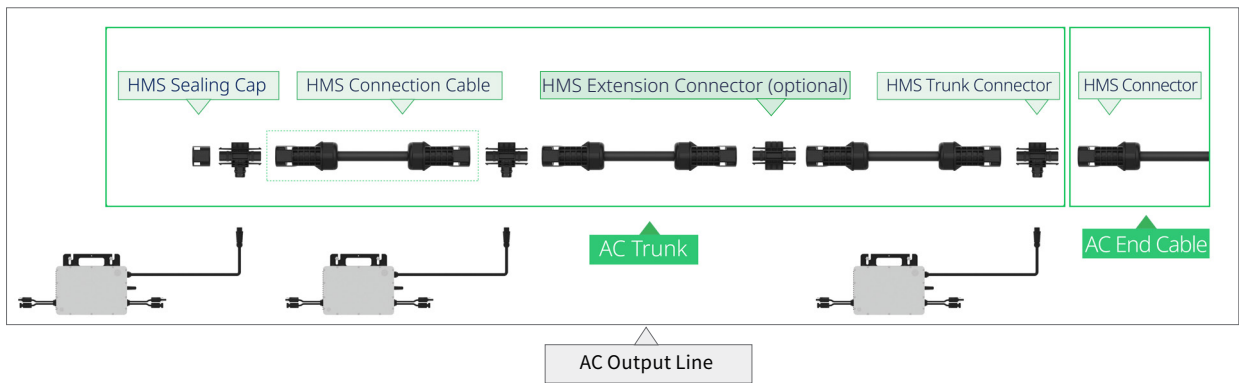

Step 1 Connect the HMS Trunk Connector

Connect the HMS Trunk Connector to the microinverter. Listen for a click as the connectors engage.

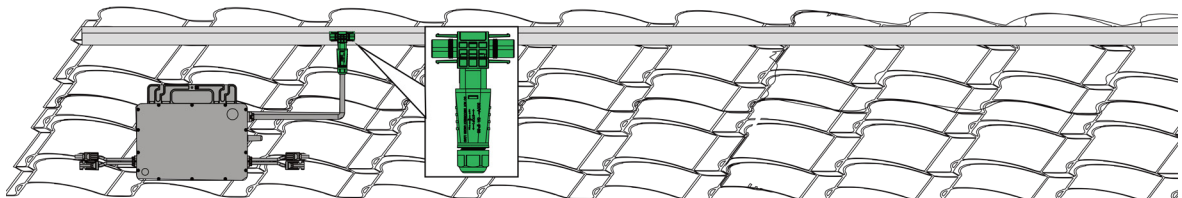
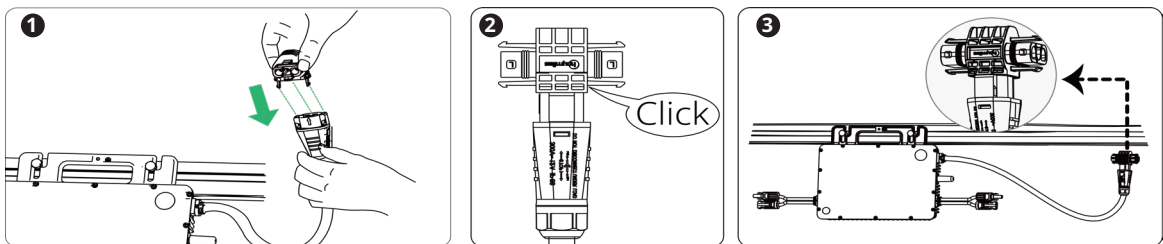

Step 2 Use the HMS Sealing Cap

Cover the unused port on the HMS Trunk Connector (located at the beginning of the AC Trunk) with an HMS Sealing Cap. Listen for a click as the sealing cap engages.

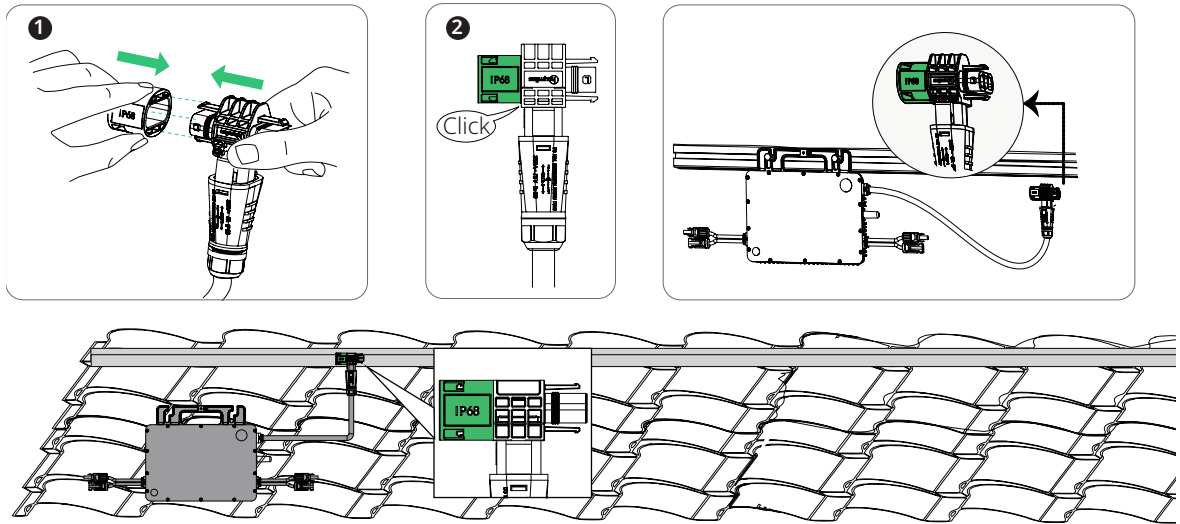

Step 3 Connect Adjacent Microinverters

Use the HMS Connection Cable to connect the adjacent HMS Trunk Connectors. Listen for a click as they engage.

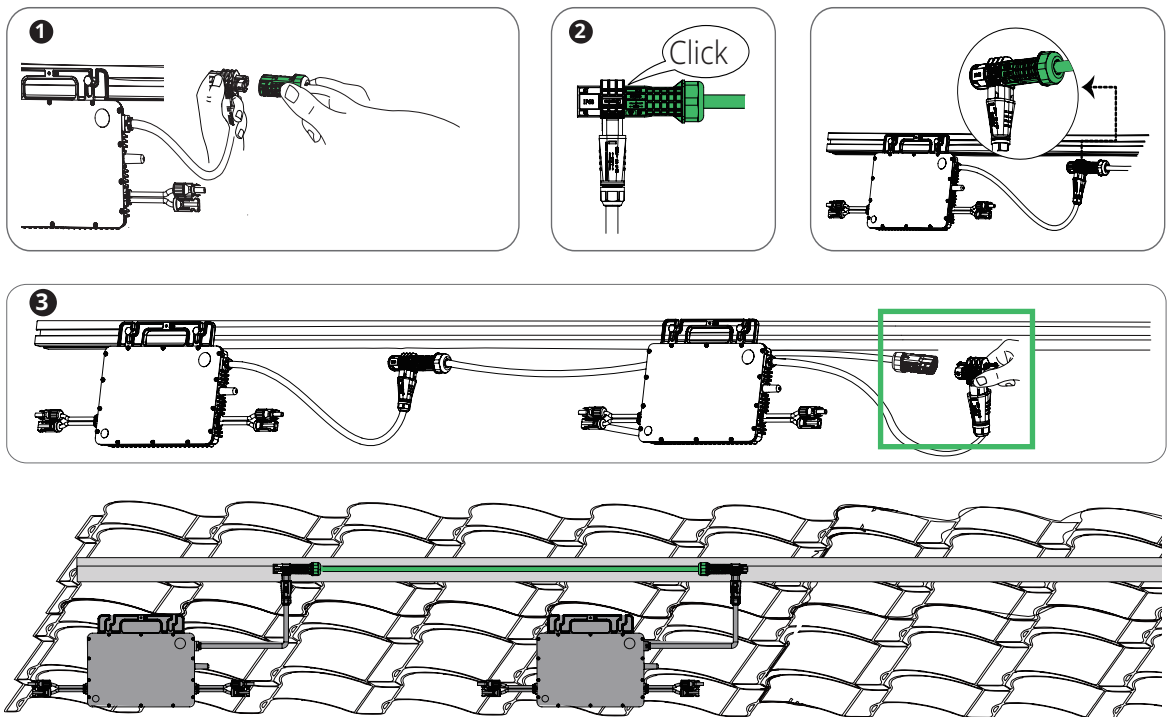

*** Rooftop Obstacle Scenario**

If your microinverters are installed too far apart, Hoymiles offers two solutions:

- Use a longer HMS Connection Cable
- Connect two HMS Extension Cables together using an HMS Extension Connector

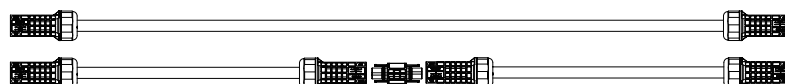

a. **Using a longer HMS Connection Cable:** Hoymiles offers various cable lengths including 1.1m, 2.3 m, and 4.6 m. If you require a different length, contact Hoymiles sales.

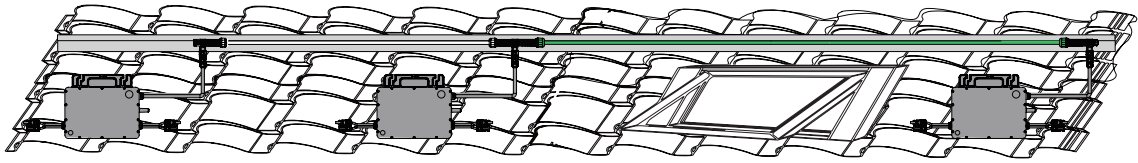

b. **Using an HMS Extension Connector:** the HMS Extension Connector can connect two HMS Connection Cables while it's not typically required. You can order it from Hoymiles if needed.

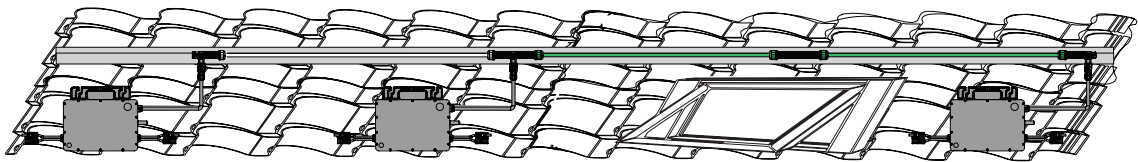

Notice: To remove the connectors or sealing cap, you must use the HMS Disconnect Tool.

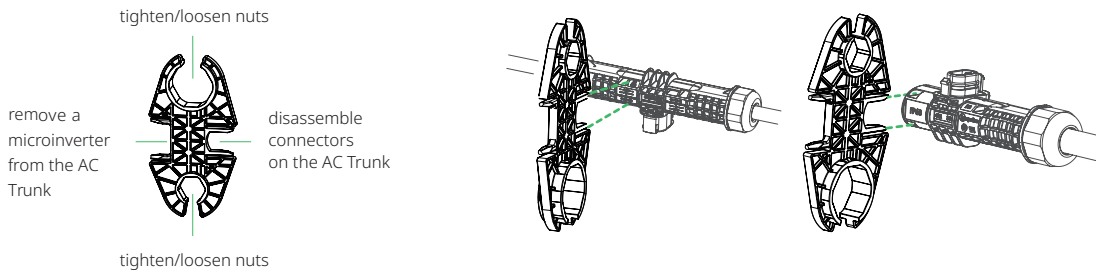

Step 4 Make the AC End Cable

a. Perapare an AC cable.

Wire Type	Core Number	Cable Diameter	Maximum Voltage
Outdoor Use, Copper Wire	Three	≤ 16.5 mm	600 V

b. Check and ensure that the HMS Connector can be separated into six parts.

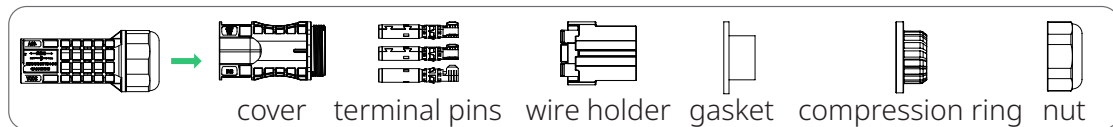

c. Push the parts through the AC cable in the correct order.

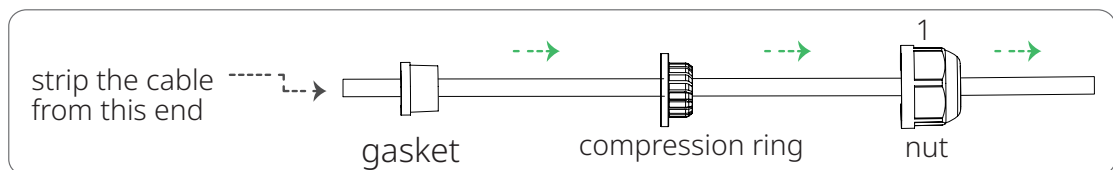

d. Strip off 40±5 mm of the outer jacket with a diagonal cutter. Then, use a wire stripper to strip the insulation, exposing 6mm-7.5 mm of the conductor.

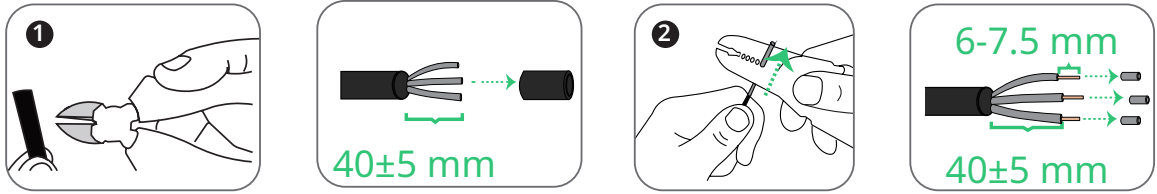

e. Insert the conductor into the terminal pin, crimp the connection, and push the crimped cable through the wire holder.

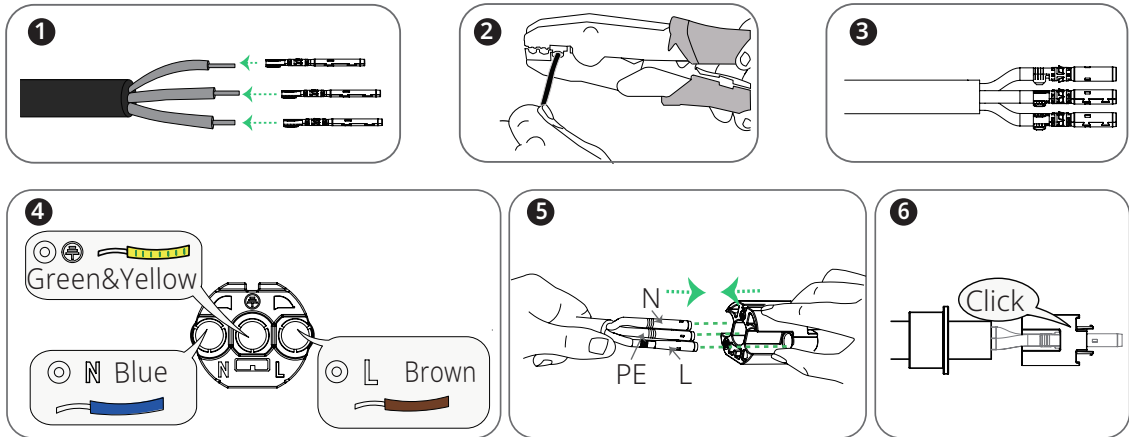

Notice: Two sizes of terminal pins are available: one for 2.5mm² cables and the other for 4mm² or 6mm² cables. Choose the correct crimp terminal size matching the cable size to ensure a reliable and secure connection. Using the wrong size can lead to potential issues or connection failures.

f. Plug the fixed cable into the HMS Connector. Then firmly tighten the nut using the HMS Disconnect Tool.

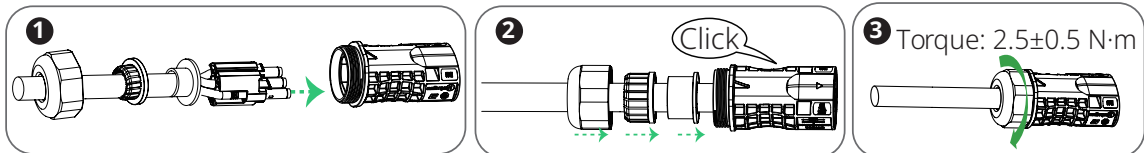

Step 5 Connect the AC End Cable

Connect the AC End Cable to the last HMS Trunk Connector in a series of cables. Listen for a click as they engage.

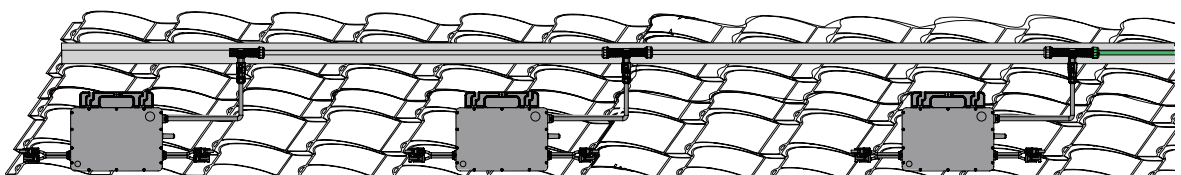
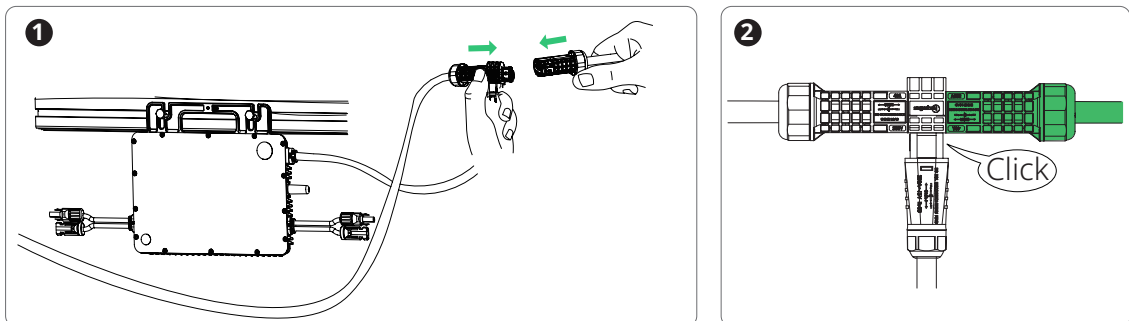

Step 6 Manage the AC Trunk

Use the cable ties to attach all cables to the racking.

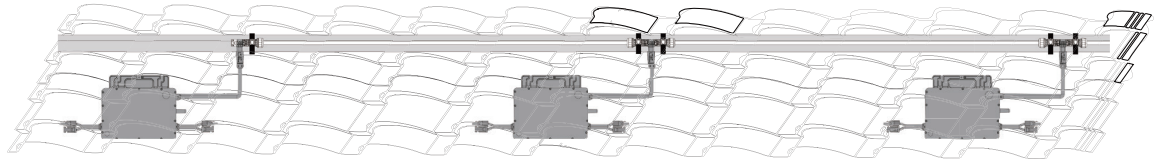
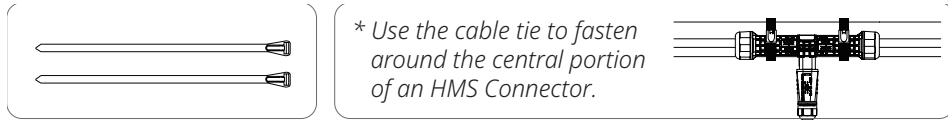

Step 7 Connect to the Distribution Box

Connect the other end of the AC End Cable to the distribution box.

Wire Colors	
L	Brown
N	Blue
PE	Green&Yellow

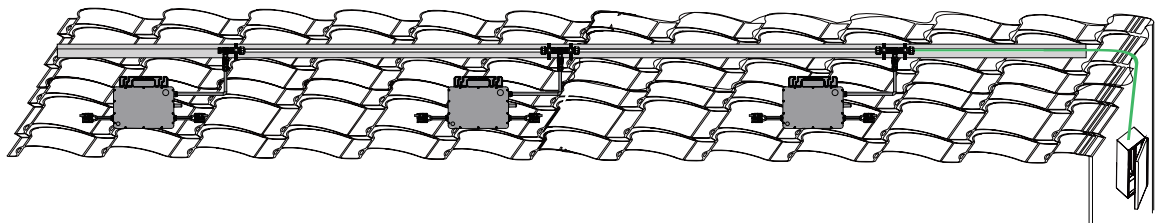

4.4 DC Side Electrical Installation

Follow the listed steps to finalize the DC side installation.

Step 1 Complete the Installation Map

- a. Peel off the removable serial number label (located near the antenna) from each microinverter.
- b. Affix the label to the respective location on the installation map.
- c. Record the Wi-Fi AP Initial Password of each microinverter for later configuration.

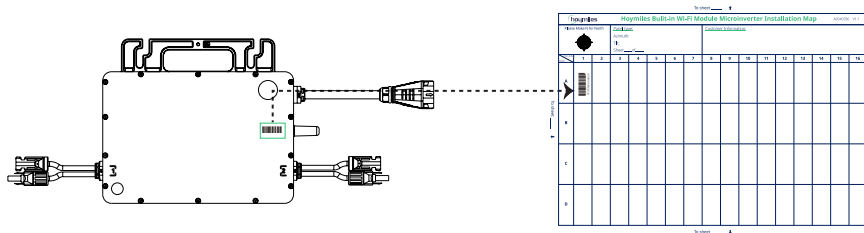

Step 2 Connect to the PV Modules

- a. Mount the PV modules above the microinverters.
- b. Connect the DC leads of PV modules to the corresponding DC inputs on the microinverters.

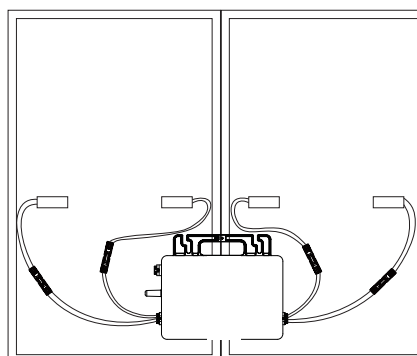

4.5 Start-up

Step 1 Energize the System

Check the following items before energizing the system:

Check Item	Acceptance Criteria
<input type="checkbox"/> Installation environment	The installation space is proper, and the installation environment is clean and tidy.
<input type="checkbox"/> Microinverter	The microinverters are installed correctly and securely.
<input type="checkbox"/> Cables routing	Cables are routed properly as required.
<input type="checkbox"/> Cable ties	Cable ties are evenly distributed and no burr exists.
<input type="checkbox"/> Cable connection	The AC output power cable and DC input power cable are connected correctly, securely, and reliably.
<input type="checkbox"/> Unused port	Unused ports are covered by HMS Sealing Caps.

For the single-microinverter system,

- a. connect the Schuko Plug or the other end of the HMS Plug and Play Cable to the socket.
- b. Wait five minutes for the system to start producing power.

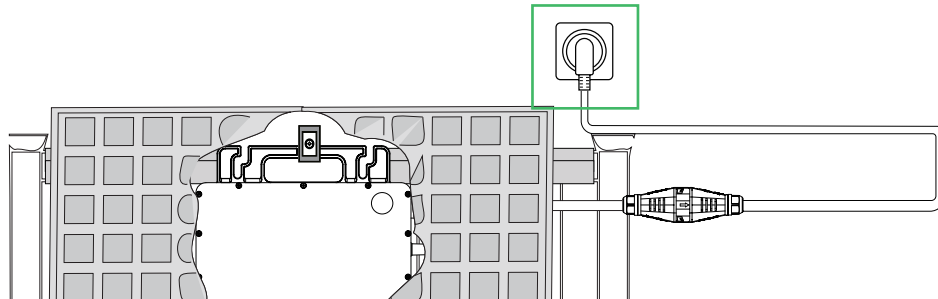

For the multi-microinverter system,

- a. Turn **ON** the AC disconnect or circuit breaker for each AC output line.
- b. Turn **ON** the main utility-grid AC circuit breaker. Wait five minutes for the system to start producing power.

Step 2 Check the LED Status

Check the LED on the connector side of the microinverter, and make sure that the microinverter operates normally.

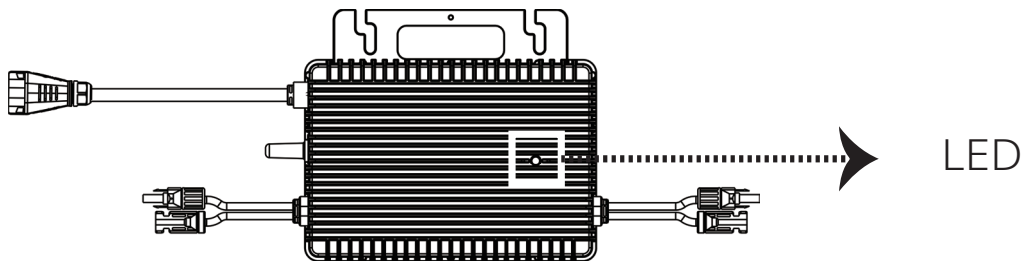

LED		Indicates
Fast Green Blink (5 times, 0.3s gap)		Start-up Success
Green Flashing (1s gap)		Producing Power
Red Flashing (1s gap)		AC Grid Fault

5. Setting Up and Activating Monitoring

This section guides you through the process of registering the system, connecting to S-Miles Cloud, setting up the power plant, adding devices, and deleting devices.

Hoymiles provides two methods to view data and monitor the operation of their microinverters:

- **Direct Connection:**

The direct connection method allows immediate access to microinverter information and control without the need to create a power plant or scan the serial number (SN).

In this method, the microinverter functions as the master, continuously transmitting Wi-Fi signals. You can connect your smartphone, equipped with the S-Miles Installer app, to the microinverter's Wi-Fi signal as a slave.

Once connected, you can access various functionalities through the S-Miles Installer app, such as checking real-time microinverter status, viewing locally stored data, and modifying specific parameters. This provides convenient and direct control over the microinverter's operation without complex setup processes.

- **Remote Connection Method:**

The remote connection method allows monitoring and control from anywhere and at any time.

To enable remote access, you need to connect the microinverter to the S-Miles cloud platform using a router. You can log in to your Hoymiles account on the S-Miles Installer app or S-Miles Cloud Platform, create an online power plant, and add the microinverter by scanning its SN code.

Once added, you can remotely access real-time data from your power plant through the S-Miles platform. Additionally, you have the ability to modify various microinverter parameters, providing convenient and flexible control over your system from a remote location.

5.1 Direct Connection

Step 1 Connect to the Internet.

- Open the S-Miles Installer app and tap the **No Account** Button.
- On the **No Account** screen, tap the **Enter** Button. This will take you to the **WLAN** page.
- On the **WLAN** page, select the microinverter's hotspot from the list and follow the prompts to configure the network connection.

 **Notice:** The network name of the microinverter consists of DTUBI and the last eight numbers of the serial number. The default password has been printed on a non-removable label affixed to the right side of the microinverter's silver-colored cover.

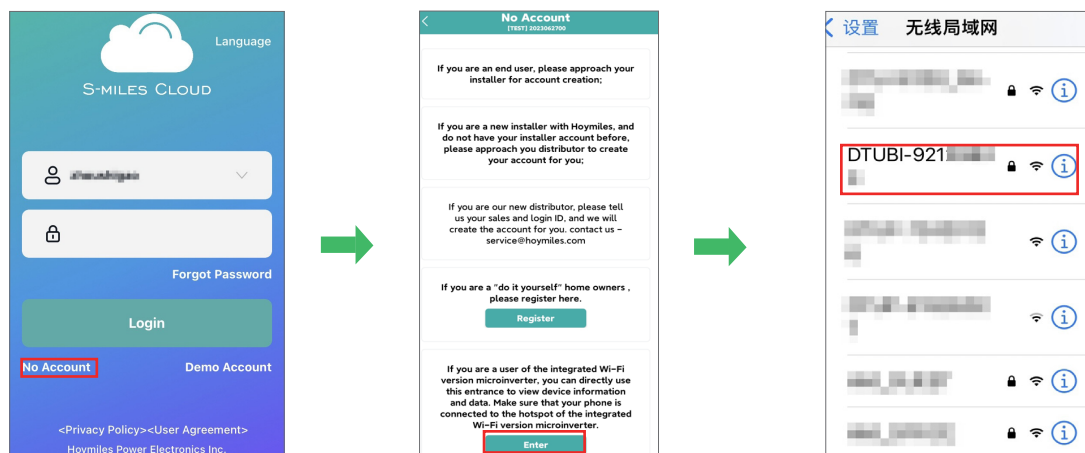
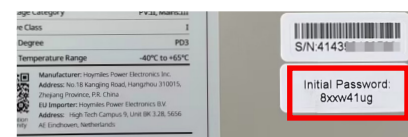

d. Once you successfully connect to the microinverter's hotspot, you will be directed to the **Overview** page.

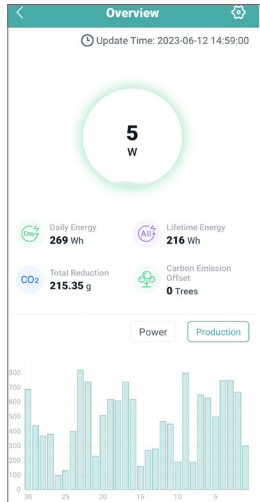

Item	Description
Setting Icon	Navigates to the Plant setting page.
Daily Energy	Daily power yield.
Lifetime Energy	The total amount of energy generated by the plant over its operational lifetime.
Total Reduction	The reduction in carbon emissions achieved through solar power generation.
Carbon Emission Offset	The green benefits through solar power generation.
Power	The line chart illustrates power generation over time.
Production	The bar graph illustrates power generation over time.

Step 3 Setting your device.

a. On the **Overview** screen, tap the **Setting** icon. This will take you to the **Device Setting** page.

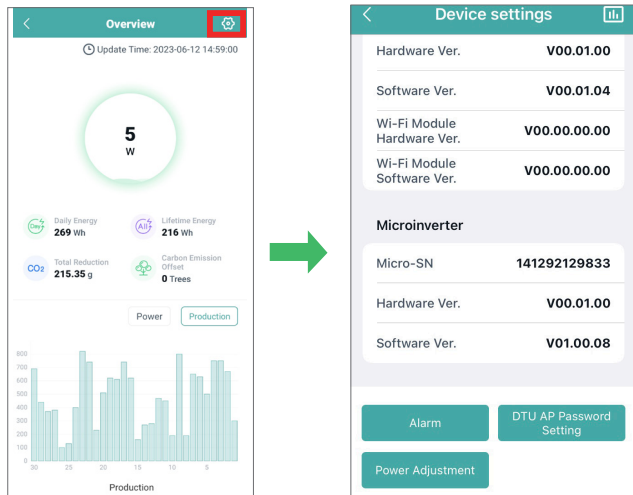

Item	Description
Alarm	Offers access to the alarm code, alarm data, and troubleshooting suggestions.
DTU AP Password Setting	Offers access to set the AP password.
Power Adjustment	Offers access to adjust the Active Power.

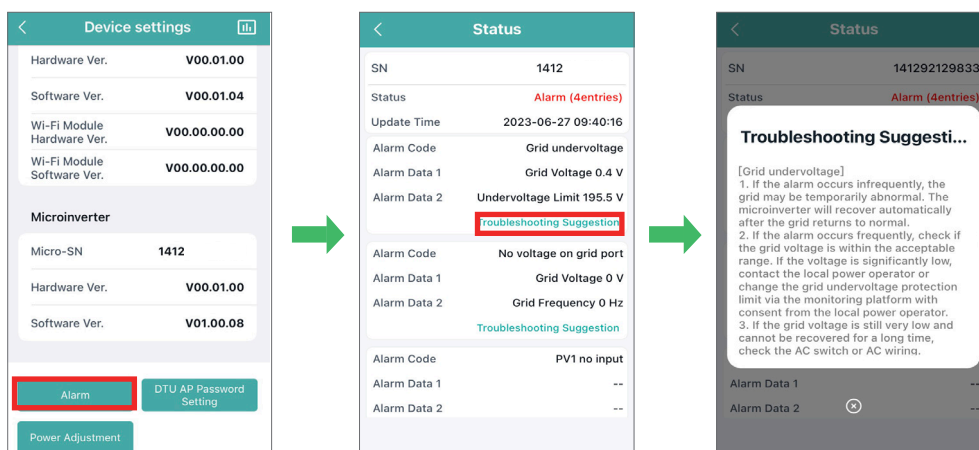

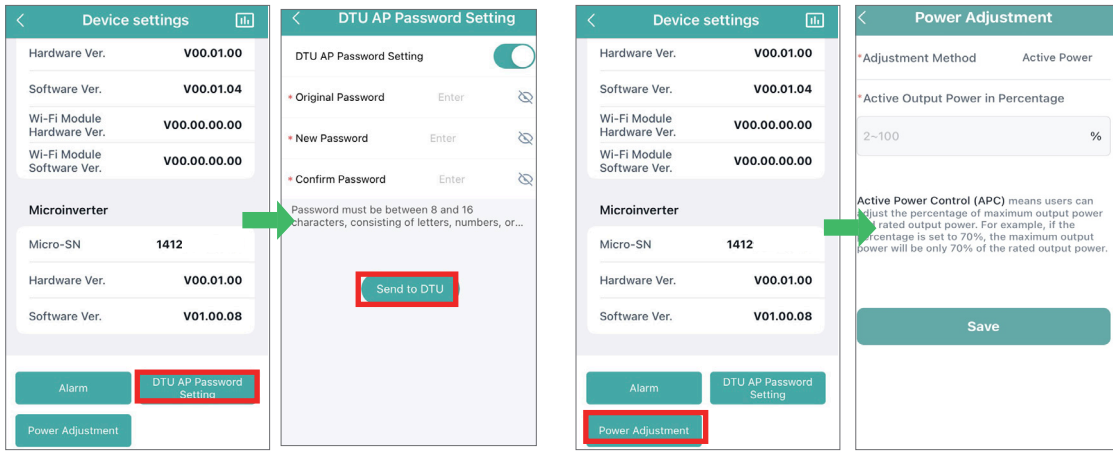

Notice: Each microinverter has been initially set with a unique AP password, which is printed on a non-removable label affixed to the right side of the microinverter's silver-colored cover. Upon receiving the microinverter, Hoymiles recommends you modify the initial AP password following the provided steps.

5.2 Remote Connection

Step 1 (Optional) Registering a DIY Account

Notice: If you have an installer account, skip this section.

- Open the S-Miles Installer application, and tap the **No Account** Button.
- On the **No Account** screen, tap the **Register** Button. This will take you to the **Register** page.
- Fill out the registration form with the required information. Then tap the **Register** button.

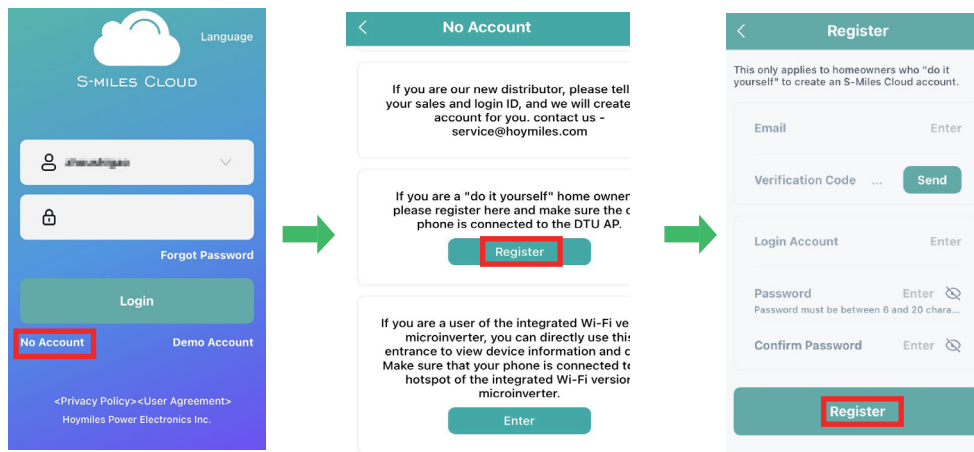

Step 2 Establishing an Internet connection.

- Open and log in to the S-Miles Installer application using your credentials. This will take you to the **Home** page.
- On the **Home** page, tap the **O&M > Network Config** icon. This will take you to the **WLAN** page.

Notice: The network name of the microinverter consists of DTUBI and the last eight numbers of the serial number, and the default password has been printed on a non-removable label affixed to the right side of the microinverter's silver-colored cover.

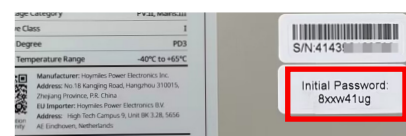

c. Follow the prompts to configure the network connection.

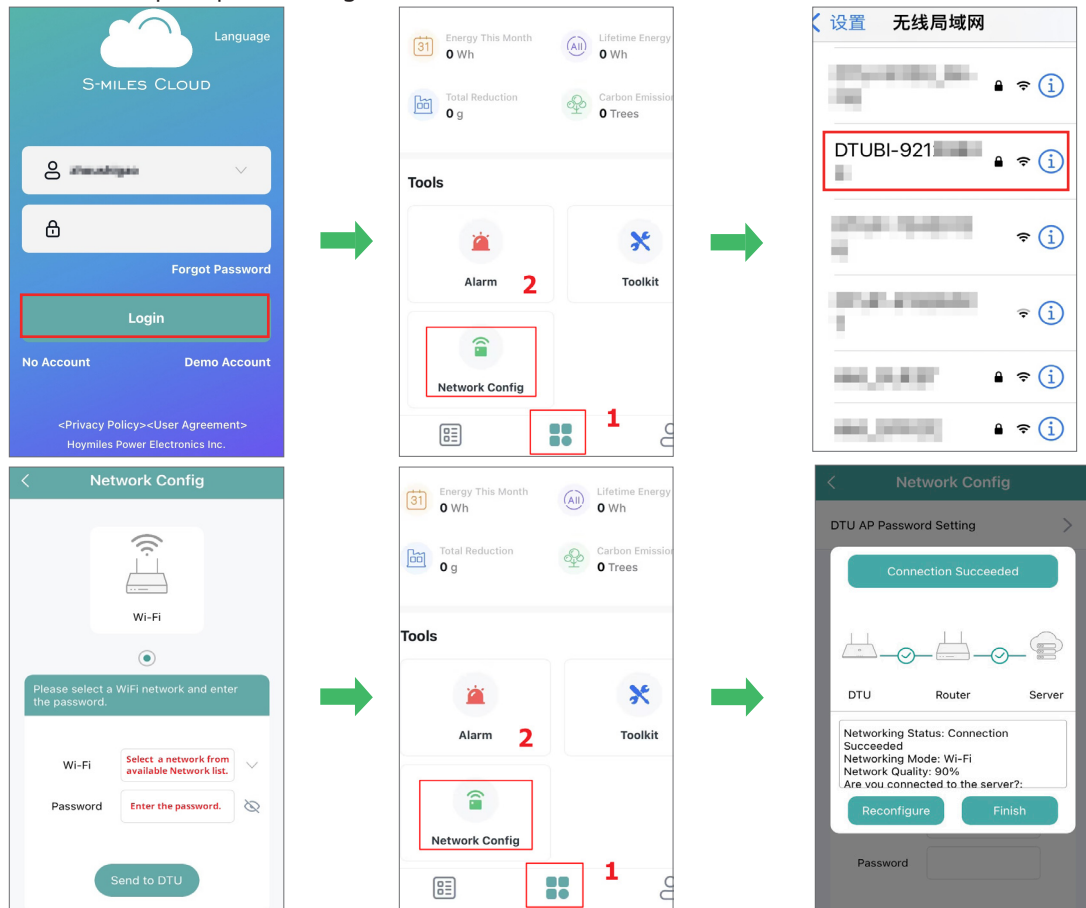

Step 2 Creating your power plant.

a. On the **Plants** screen, tap the **Add Plant** icon.

b. Follow the prompts to fill in the required information.

c. Tap the **Save** button to finalize the power plant creation.

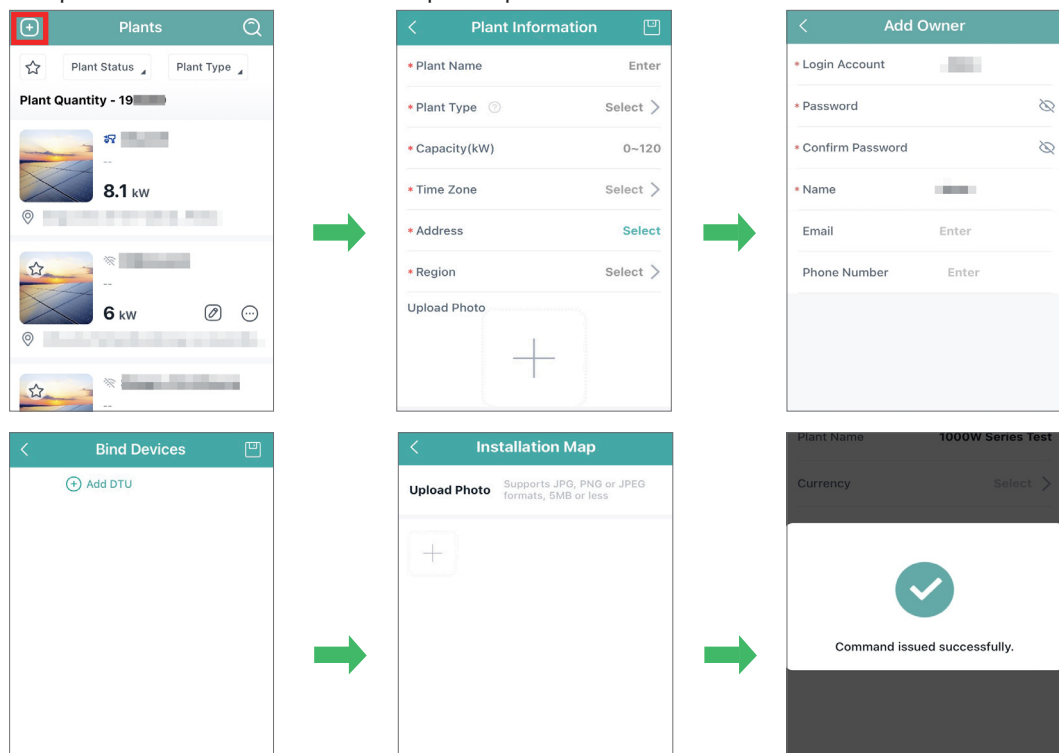

Notice: For more information about power plant deployment, see [S-Miles Installer App Operating Guide](#).

Step 3 Setting your power plant.

- a. On the **Plants** screen, tap the **Search** icon.
- b. Enter the desired plant name for your search.
- c. Tap the plant name to move to the plant homepage.

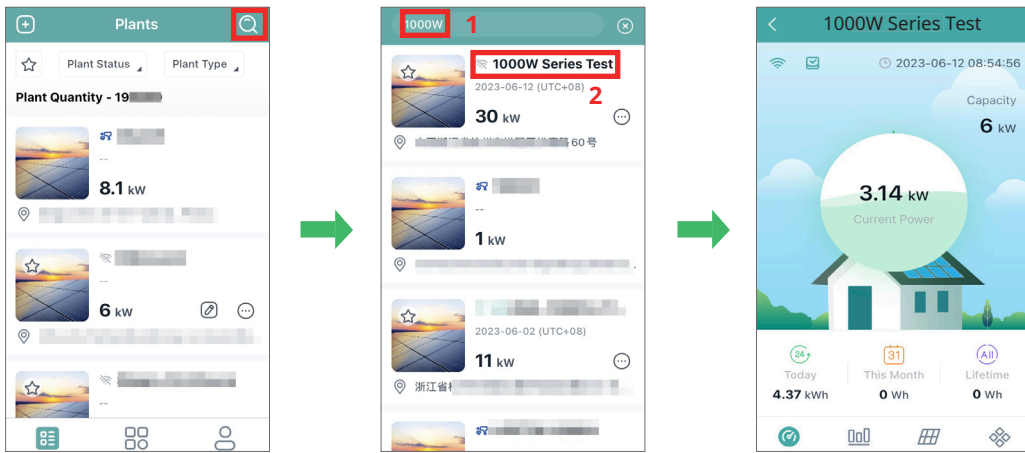

- d. On the plant homepage, tap the **Setting** icon. This will take you to the **Plant Setting** page.

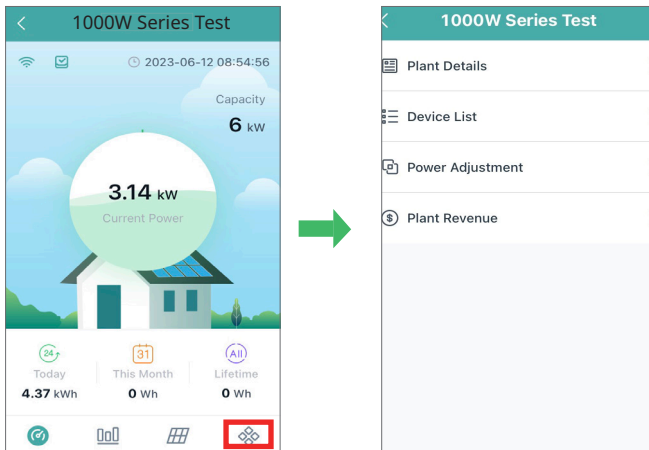

Item	Description
Plant Details	This function offers access to geographical location, system capacity, and owner information about your power plant.
Device List	This function provides an SN list of devices installed in your power plant.
Power Adjustment	This function offers access to adjust the Active Power.
Plant Revenue	This function provides revenue data over the electricity price, real-time power production data, and historical power production data.

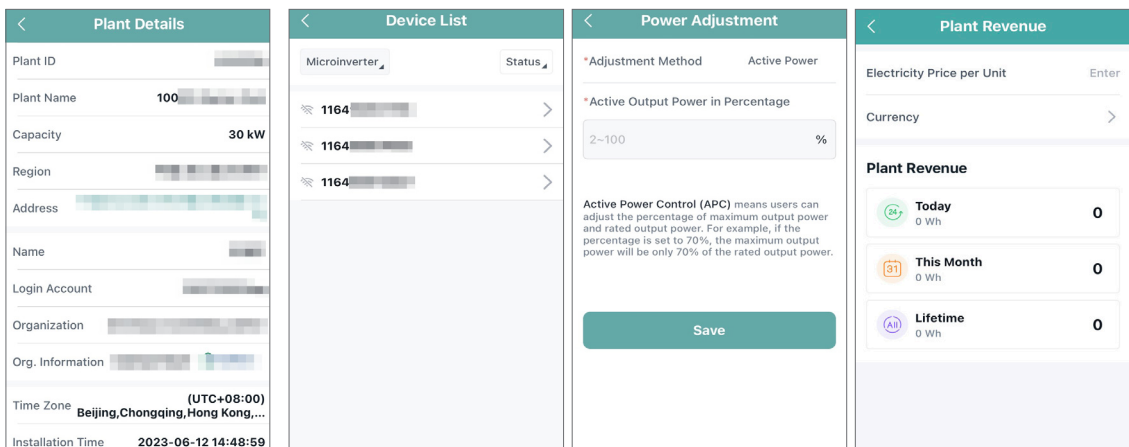

6. Troubleshooting

6.1 Troubleshooting List

Code	Alarm range	Alarm status	Handling suggestions
121		Over temperature protection	<ol style="list-style-type: none"> 1. Check the ventilation and ambient temperature at the microinverter installation position. 2. Improve ventilation and heat dissipation if necessary. 3. If both the ventilation and ambient temperature meet the requirements, contact your dealer or Hoymiles technical support.
125		Grid configuration parameter error	<ol style="list-style-type: none"> 1. Check if the grid configuration parameter is correct and upgrade again. 2. If the fault still exists, contact your dealer or Hoymiles technical support.
126		Software error code 126	<ol style="list-style-type: none"> 1. If the alarm occurs accidentally and the microinverter can still work normally, no special treatment is required. 2. If the alarm occurs frequently and cannot be recovered, contact your dealer or Hoymiles technical support.
127		Firmware error	<ol style="list-style-type: none"> 1. Check if the firmware is correct and upgrade again. 2. Check and ensure proper communication between DTU, Hoymiles monitoring system, and microinverter. Retry if needed. 3. If the fault still exists, contact your dealer or Hoymiles technical support.
128		Software error code 128	<ol style="list-style-type: none"> 1. No action needed if the alarm is accidental and the microinverter functions normally. 2. If the alarm occurs frequently and cannot be recovered, contact your dealer or Hoymiles technical support.
129		Software error code 129	<ol style="list-style-type: none"> 1. If the alarm occurs accidentally and the microinverter can still work normally, no special treatment is required. 2. If the alarm occurs frequently and cannot be recovered, contact your dealer or Hoymiles technical support.
130		Offline	<ol style="list-style-type: none"> 1. Please make sure that the microinverter works normally. 2. Check the communication status between the DTU and Hoymiles monitoring system or between the DTU and the microinverter. If the communication is poor, try to make some improvements. 3. If the alarm occurs frequently and cannot be recovered, contact your dealer or Hoymiles technical support.
141	Grid	Grid overvoltage	<ol style="list-style-type: none"> 1. If the alarm occurs accidentally, the grid voltage may be abnormal temporarily. The microinverter can recover automatically after the grid voltage becomes normal. 2. If the alarm occurs frequently, check whether the grid voltage is within the acceptable range. If no, contact the local power operator or change the grid overvoltage protection limit via the Hoymiles monitoring system with the consent of the local power operator.
142	Grid	10 min value grid overvoltage	<ol style="list-style-type: none"> 1. If the alarm occurs accidentally, the grid voltage may be abnormal temporarily. The microinverter can recover automatically after the grid voltage becomes normal. 2. If the alarm occurs frequently, check whether the grid voltage is within the acceptable range. If no, contact the local power operator or change the grid overvoltage protection limit via the Hoymiles monitoring system with the consent of the local power operator.
143	Grid	Grid undervoltage	<ol style="list-style-type: none"> 1. If the alarm occurs accidentally, the grid voltage may be abnormal temporarily. The microinverter can recover automatically after the grid voltage becomes normal. 2. If the alarm occurs frequently, check whether the grid voltage is within the acceptable range. If no, contact the local power operator or change the grid overvoltage protection limit via the Hoymiles monitoring system with the consent of the local power operator.

144	Grid	Grid overfrequency	<ol style="list-style-type: none"> 1. If the alarm occurs accidentally, the grid frequency may be abnormal temporarily. The microinverter can recover automatically after the grid frequency becomes normal. 2. If the alarm occurs frequently, check whether the grid frequency is within the acceptable range. If no, contact the local power operator or change the grid overfrequency protection limit via the Hoymiles monitoring system with the consent of the local power operator.
145	Grid	Grid underfrequency	<ol style="list-style-type: none"> 1. If the alarm occurs accidentally, the grid frequency may be abnormal temporarily. The microinverter can recover automatically after the grid frequency becomes normal. 2. If the alarm occurs frequently, check whether the grid frequency is within the acceptable range. If no, contact the local power operator or change the grid underfrequency protection limit via the Hoymiles monitoring system with the consent of the local power operator.
146	Grid	Rapid grid frequency change rate	<ol style="list-style-type: none"> 1. If the alarm occurs accidentally, the grid frequency may be abnormal temporarily. The microinverter can recover automatically after the grid frequency becomes normal. 2. If the alarm occurs frequently, check whether the grid frequency change rate is within the acceptable range. If no, contact the local power operator or change the grid frequency change rate limit via the Hoymiles monitoring system with the consent of the local power operator.
147	Grid	Power grid outage	Please check whether there is a power grid outage.
148	Grid	Grid disconnection	Please check whether the AC switch or AC wiring is normal.
149	Grid	Island detected	<ol style="list-style-type: none"> 1. If the alarm occurs accidentally, the grid voltage may be abnormal temporarily. The microinverter can recover automatically after the grid voltage becomes normal. 2. If the alarms occur frequently on all the microinverters in your station, contact the local power operator to check whether there is a grid island. 3. If the alarm still exists, contact your dealer or Hoymiles technical support.
171		Abnormal phase difference between phase to phase	Please check that the wiring of each phase is completely correct. This fault is usually caused by the wrong phase.
205		Input port 1&2 overvoltage	<ol style="list-style-type: none"> 1. Please make sure that the PV module open-circuit voltage is less than or equal to the maximum input voltage. 2. If the PV module open-circuit voltage is within the normal range, contact your dealer or Hoymiles technical support.
206		Input port 3&4 overvoltage	<ol style="list-style-type: none"> 1. Please make sure that the PV module open-circuit voltage is less than or equal to the maximum input voltage. 2. If the PV module open-circuit voltage is within the normal range, contact your dealer or Hoymiles technical support.
207		Input port 1&2 undervoltage	<ol style="list-style-type: none"> 1. Please make sure that the PV module open-circuit voltage is less than or equal to the maximum input voltage. 2. If the PV module open-circuit voltage is within the normal range, contact your dealer or Hoymiles technical support.
208		Input port 3&4 undervoltage	<ol style="list-style-type: none"> 1. Please make sure that the PV module open-circuit voltage is less than or equal to the maximum input voltage. 2. If the PV module open-circuit voltage is within the normal range, contact your dealer or Hoymiles technical support.
209		Port 1 No input	<ol style="list-style-type: none"> 1. Please confirm whether this port is connected to the PV module; 2. If the PV module is connected, please check the DC cable connection between this port and the PV module.
210		Port 2 No input	<ol style="list-style-type: none"> 1. Please confirm whether this port is connected to the PV module; 2. If the PV module is connected, please check the DC cable connection between this port and the PV module.

211		Port 3 No input	<ol style="list-style-type: none"> 1. Please confirm whether this port is connected to the PV module; 2. If the PV module is connected, please check the DC cable connection between this port and the PV module.
212		Port 4 No input	<ol style="list-style-type: none"> 1. Please confirm whether this port is connected to the PV module; 2. If the PV module is connected, please check the DC cable connection between this port and the PV module.
213		PV-1 & PV-2 abnormal wiring	Please check whether the DC connections on port 1 and 2 are correct.
214		PV-3 & PV-4 abnormal wiring	Please check whether the DC connections on port 3 and 4 are correct.
221		Abnormal wiring of grid neutral line	Please confirm whether the grid neutral lines of the microinverters are connected to the neutral of the grid correctly.
301		Hardware Error Code 301	<ol style="list-style-type: none"> 1. If the alarm occurs accidentally and the microinverter can still work normally, no special treatment is required. 2. If the alarm occurs frequently and cannot be recovered, contact your dealer or Hoymiles technical support.
302		Hardware Error Code 302	<ol style="list-style-type: none"> 1. If the alarm occurs accidentally and the microinverter can still work normally, no special treatment is required. 2. If the alarm occurs frequently and cannot be recovered, contact your dealer or Hoymiles technical support.
303		Hardware Error Code 303	<ol style="list-style-type: none"> 1. If the alarm occurs accidentally and the microinverter can still work normally, no special treatment is required. 2. If the alarm occurs frequently and cannot be recovered, contact your dealer or Hoymiles technical support.
304		Hardware Error Code 304	<ol style="list-style-type: none"> 1. If the alarm occurs accidentally and the microinverter can still work normally, no special treatment is required. 2. If the alarm occurs frequently and cannot be recovered, contact your dealer or Hoymiles technical support.
305		Hardware Error Code 305	<ol style="list-style-type: none"> 1. If the alarm occurs accidentally and the microinverter can still work normally, no special treatment is required. 2. If the alarm occurs frequently and cannot be recovered, contact your dealer or Hoymiles technical support.
306		Hardware Error Code 306	<ol style="list-style-type: none"> 1. If the alarm occurs accidentally and the microinverter can still work normally, no special treatment is required. 2. If the alarm occurs frequently and cannot be recovered, contact your dealer or Hoymiles technical support.
307		Hardware Error Code 307	<ol style="list-style-type: none"> 1. If the alarm occurs accidentally and the microinverter can still work normally, no special treatment is required. 2. If the alarm occurs frequently and cannot be recovered, contact your dealer or Hoymiles technical support.
308		Hardware Error Code 308	<ol style="list-style-type: none"> 1. If the alarm occurs accidentally and the microinverter can still work normally, no special treatment is required. 2. If the alarm occurs frequently and cannot be recovered, contact your dealer or Hoymiles technical support.
309		Hardware Error Code 309	<ol style="list-style-type: none"> 1. If the alarm occurs accidentally and the microinverter can still work normally, no special treatment is required. 2. If the alarm occurs frequently and cannot be recovered, contact your dealer or Hoymiles technical support.
310		Hardware Error Code 310	<ol style="list-style-type: none"> 1. If the alarm occurs accidentally and the microinverter can still work normally, no special treatment is required. 2. If the alarm occurs frequently and cannot be recovered, contact your dealer or Hoymiles technical support.
311		Hardware Error Code 311	<ol style="list-style-type: none"> 1. If the alarm occurs accidentally and the microinverter can still work normally, no special treatment is required. 2. If the alarm occurs frequently and cannot be recovered, contact your dealer or Hoymiles technical support.

6.2 LED Indicator Status

The LED light on the microinverter indicates various statuses. The following table details the possible LED statuses and what they mean.

(1) During Start-up
• Flashing green five times (0.3s gap): Start-up Success
• Flashing red five times (0.3s gap): Microinverter Failure
• Alternating red and green flashing (1s gap): Firmware Corrupt
(2) During Operation
• Flashing green (1s gap): Normal Power Production
• Flashing green (2s gap): Producing power, but one or more input is abnormal.
• Flashing red (0.5s gap): Control Unit Failure
• Flashing red (1s gap): AC Grid Fault
• Solid red: Hardware Failure



Notice:

- The microinverter is powered by the DC side. If the LED light is not on, check the DC side connection.
- If the connection and input voltage are normal, contact your dealer or Hoymiles technical support team for further assistance.
- All faults are reported to the S-Miles Cloud. For more information, refer to the S-Miles Installer/Enduser App or S-Miles Cloud.
- Ensure the grid connection is normal.

6.3 AP Password Troubleshooting

If you reset the microinverter's password and later forget it, you can revert to the initial password using the following method.



Notice:

- This process has a time limit of **20 minutes**, and it must be completed within that timeframe.
- For forgotten initial passwords, you can contact Hoymiles Technical Support for assistance.
- **For Single-Microinverter System:**
 1. Ensure the grid connection status is normal.
 2. Unplug the plug and disconnect the grid voltage for 5 to 10s.
 3. Plug in the plug and allow the grid voltage to continue for at least 5 to 10s.
 4. Unplug the plug and disconnect the grid voltage for 5 to 10s.
 5. Plug in the plug and allow the grid voltage to continue normally for at least 5s.
- **For Multi-Microinverter systems:**
 1. Ensure the grid connection status is normal.
 2. Disconnect the circuit breaker and grid voltage for 5 to 10s.
 3. Reconnect the circuit breaker and allow the grid voltage to continue normally for 5 to 10s.
 4. Repeat the disconnection of the circuit breaker and grid voltage for 5 to 10s.
 5. Reconnect the circuit breaker and allow the grid voltage to continue normally for at least 5s.



6.4 Wireless Network Troubleshooting

If there is a poor Wi-Fi signal strength indicated with signal bars in the S-Miles Installer application or if the S-Miles Cloud platform/S-Miles Installer application sometimes not displaying data, the problem could be the microinverter system’s Wi-Fi connection.

To troubleshoot this problem, please follow the procedure listed below.

Description	Procedure								
<p>An Unstable Internet Connection icon next to the plant name has been displayed in the S-Miles Installer application.</p>	<p>Microinverter:</p> <p>Restart the microinverter via the S-Miles Cloud platform or S-Miles Installer application. If the Wi-Fi signal strength is still weak, go to check the router.</p> <p>Router:</p> <ol style="list-style-type: none"> 1. Check whether the router is using the 2.4G band, 5G band or using both 2.4G and 5G bands. If the router is using 2.4G band or using both 2.4G and 5G bands, proceed to step 2. Otherwise, change the router from 5G to 2.4G, then back to the home page. If the unstable issue persists, proceed to step 2. 2. Check the signal strength of the router by connecting your phone or other devices to it. If the signal strength in your phone (or other devices) is good, proceed to step 3. Otherwise, go to check the wireless environment. 3. Reboot the router. <p>Wireless Environment (for DIY Users or Professional Users) :</p> <ol style="list-style-type: none"> 1. Check the wireless environment of the PV plant with Wi-Fi scanning software: <ol style="list-style-type: none"> a) Check the signal strength of your wireless connection, and make sure there is an ideal signal strength based on the requirements for the network. If the signal strength is good (> -65 dBm), proceed to step b. If the signal strength is weak (< -65 dBm), try to move the router closer to the microinverters. After this, if the signal strength is still weak, proceed to step b. <table border="1" style="margin-left: 20px;"> <thead> <tr> <th>Signal Strength (dBm)</th> <th>Qualifier</th> </tr> </thead> <tbody> <tr> <td>> -30</td> <td>Excellent</td> </tr> <tr> <td>-30 to -65</td> <td>Vey Good</td> </tr> <tr> <td>> -65</td> <td>Bad</td> </tr> </tbody> </table> <ol style="list-style-type: none"> b) Check whether there is interference from other nearby wireless networks. If your wireless network is affected by Wi-Fi interference, try to conquer the Wi-Fi interference by manually changing the router to another Wi-Fi channel that no one else is using. Otherwise, proceed to step 2. 2. Contact the network operator and ask about the network problems. 3. Add a Wi-Fi booster to your network. If the Wi-Fi signal is still weak. 	Signal Strength (dBm)	Qualifier	> -30	Excellent	-30 to -65	Vey Good	> -65	Bad
Signal Strength (dBm)	Qualifier								
> -30	Excellent								
-30 to -65	Vey Good								
> -65	Bad								
<p>S-Miles Cloud or S-Miles Installer application sometimes not displaying data.</p>	<ol style="list-style-type: none"> 1. Repeat the preceding steps to check your network connection status. 2. If the problem persists, contact your installer. 								

6.5 On-Site Instruction (for qualified installers only)

 DANGER	<ul style="list-style-type: none"> Do not attempt to dismantle or repair the microinverter! No user-serviceable parts inside for safety and insulation reasons! Only authorized personnel are allowed to carry out the maintenance operations and are responsible for reporting any anomalies. Always use personal protective equipment provided by the employer during maintenance operations. Stop the microinverter and disconnect it from all power supplies before maintenance. Lethal voltage still exists in the inverter. Please wait for at least 5 minutes, and then perform maintenance work. DO NOT use the equipment if any problems are detected. Restore its working conditions after the fault is fixed.
 WARNING	<ul style="list-style-type: none"> During normal operation, check the environmental conditions regularly to make sure that the conditions
 CAUTION	<ul style="list-style-type: none"> In order to maintain good ventilation, please check to make sure the heatsink covers are not blocked. Clean the heatsink cover with a soft brush or vacuum cleaner if necessary. Conduct annual inspections on various components, and clean the equipment with a vacuum cleaner or special brushes.

Check that:

- The utility voltage and frequency are within the respective range (see [Technical Data](#)).
- The PV modules' DC voltage is within the allowable range (see [Technical Data](#)).

Check the connection to the utility grid.

Procedure

- a. Disconnect the AC power to de-energize the microinverter.
 - b. Disconnect the DC power.
 - c. Re-connect the PV modules to the microinverter.
 - d. If the LED flashes red, indicating a normal DC connection.
 - e. Re-connect the AC power.
 - f. If the LED flashes green five times, indicating a normal DC and AC connection.
 - g. Re-connect the DC module connectors and wait for five short LED flashes.
 - h. If the problem persists, please contact Hoymiles Technical Support Team service@hoymiles.com.

- The microinverter is energized by the utility grid as described in the previous step (see [AC Side Installation](#)).
- Every AC breaker is functioning properly and is closed.
- The DC connection between the microinverter and the PV module is functioning.



Notice: If the problem persists, please contact Hoymiles Technical Support Team service@hoymiles.com.

7. Decommission

This chapter explains how to remove, replace, store, and recycle microinverter at the end of its lifetime.



- *Dangerous voltage may still be present inside, even after the microinverter is disconnected.*
- *Do not dispose of microinverter with normal waste.*

7.1 Removing the Microinverter

Procedure

- Switch **OFF** the AC circuit breakers.
- Disconnect all AC connections.
- Remove the PV modules from the racking, and cover the PV modules.
- Use an electric meter or current clamp to ensure that no current is present in the DC cables between the microinverters and PV modules.
- Disconnect all DC cable connections.
- Remove protective earthing connections (if needed).
- Loosen the fixing screws on the top of the microinverter and remove the microinverter from the mounting racking.

7.2 Replacing the Microinverter

Procedure

- Record the new microinverter's SN.
- Switch **OFF** the AC circuit breakers.
- Install the replacement unit. (See [Mechanical Installation](#) and [Electrical Installation](#)).
- Replace the microinverter in the monitoring platform.
 - Log in to the S-Miles Cloud at <https://world.hoymiles.com>.
 - Navigate to **O&M > Micro > Search**, find the device that you want to replace, and then click the **Device Maintenance** icon.

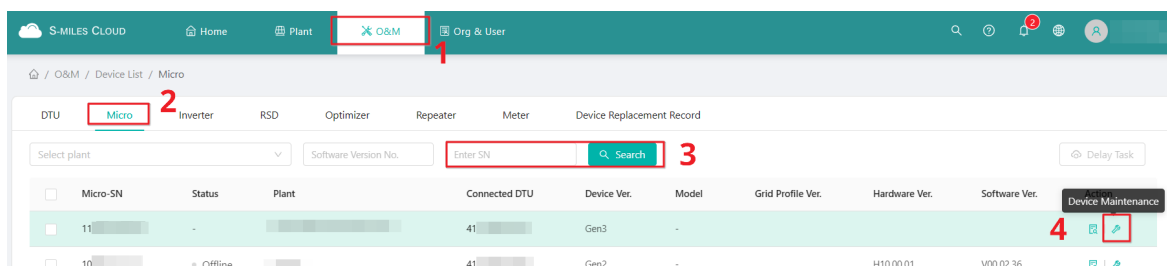

- On the **Device Maintenance** dialogue, click the **Replace Device** button.

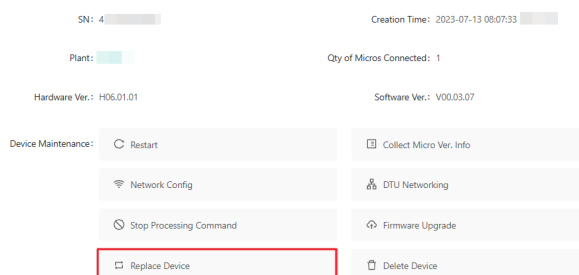

- Enter the new microinverter's SN, and then click **Confirm** button to replace the microinverter.

Replace Device

Original Device SN: 41 1

* Current Device SN: SN 2

Cancel Confirm

7.3 Storing and Transporting the Microinverter

The following requirements should be met if the microinverter is not put into use directly.

- Pack the microinverter in the original packaging. If the original packaging is no longer available, you can use a carton box that can hold 5 kg and can be fully closed.
- Keep the storage temperature within -40°C to 85°C.
- The equipment must be stored indoors with good ventilation.
- Protect the microinverter from physical shocks or vibration during transport and storage.
- Avoid tilt or jolt during transportation.
- Observe the general transport regulations based on the mode of transport as well as all legal regulations.
- Take a complete inspection when restarting the equipment after it has stopped operation for a long time.
- In the case of stacking storage, the number of stacking layers should never exceed the limit marked on the outer side of the packing case.

7.4 Disposing of the Microinverter

Procedure

- a. Properly pack the microinverter in the original packaging. If the original packaging is no longer available, you can use a carton box that can hold 5 kg and can be fully closed.
- b. Properly seal the package with adhesive tape.
- c. Dispose of the package according to the local regulations.

8. Technical Data





Be sure to verify the following before installing Hoymiles Microinverter System.

- Verify PV module voltage and current specifications match the microinverter's.
 - Ensure the PV module's maximum open circuit voltage is within the microinverter's operating voltage range.
 - Hoymiles recommends the maximum current rating at MPP to be equal to or lower than the maximum input DC current.
- PV module output DC power must not exceed 1.35 times the microinverter's output AC power. See "Hoymiles Warranty Terms & Conditions" for details.

Model	HMS-600W-2T	HMS-700W-2T	HMS-800W-2T	HMS-900W-2T	HMS-1000W-2T
Input Data (DC)					
Commonly used module power (W)	240 to 405+	280 to 470+	320 to 540+	360 to 600+	400 to 670+
Maximum input voltage (V)	60	60	65	65	65
MPPT voltage range (V)	16-60				
Min./Max. start voltage (V)	22/60				
Maximum input current (A)	2 × 12	2 × 13	2 × 14	2 × 15	2 × 16
Maximum input short circuit current (A)	2 × 20	2 × 20	2 × 25	2 × 25	2 × 25
Number of MPPTs	2				
Number of inputs per MPPT	1				
Output Data (AC)					
Rated output power (VA)	600	700	800	900	1000
Rated output current (A)	2.61	3.04	3.48	3.91	4.35
Nominal output voltage/range (V)*	230/180-275				
Nominal frequency/range (Hz)*	50/45-55				
Power factor(adjustable)	>0.99 default 0.8 leading ... 0.8 lagging				
Total harmonic distortion	< 3%				
Maximum units per line (2.5 mm ²)	9	7	6	6	5
HMS Plug and Play Cable (Optional)					
Connector type	HMS Field Connector				
Cable size	1.5 mm ²				
Cable length	3 m (Customizable)				
Plug type	Schuko				
Efficiency					
CEC peak efficiency	96.70%	96.70%	96.70%	96.50%	96.50%
Nominal MPPT efficiency	99.80%				
Night power consumption (mW)	< 50				
Mechanical Data					
Ambient temperature range (°C)	-40 to +65				
Storage temperature range (°C)	-40 to +85				
Dimensions (W × H × D mm)	261 × 180 × 35.1				
Weight (kg)	3.2				
Enclosure rating	Outdoor-IP67				
Cooling	Natural convection – No fans				
Features					
Communication	Built-in Wi-Fi				
Topology	Galvanically Isolated HF Transformer				
Monitoring	Micro Toolkit or S-Miles Cloud				
Compliance	VDE-AR-N 4105: 2018, EN 50549-1: 2019, VFR 2019, IEC/EN 62109-1/-2, IEC/EN 61000-6-1/-2/-3/-4, IEC/EN 61000-3-2/-3				
*: Nominal voltage/frequency range may vary based on local requirements.					

9. Appendix 1: Installation Map

↑ To sheet _____

 Please Make N for North 		Hoy miles Microinverter Installation Map										DTU Serial Number						
		Customer Information:																
Panel type: Azimuth: Tilt: Sheet ___ of ___	1	2	3	4	5	6	7	8	9	10	11	12	13	14	15	16		
	COLUMN	ROW	A	B	C	D												

↓ To sheet _____

To sheet _____ ↓

10. Appendix 2: WIRING DIAGRAM - 230VAC SINGLE PHASE:

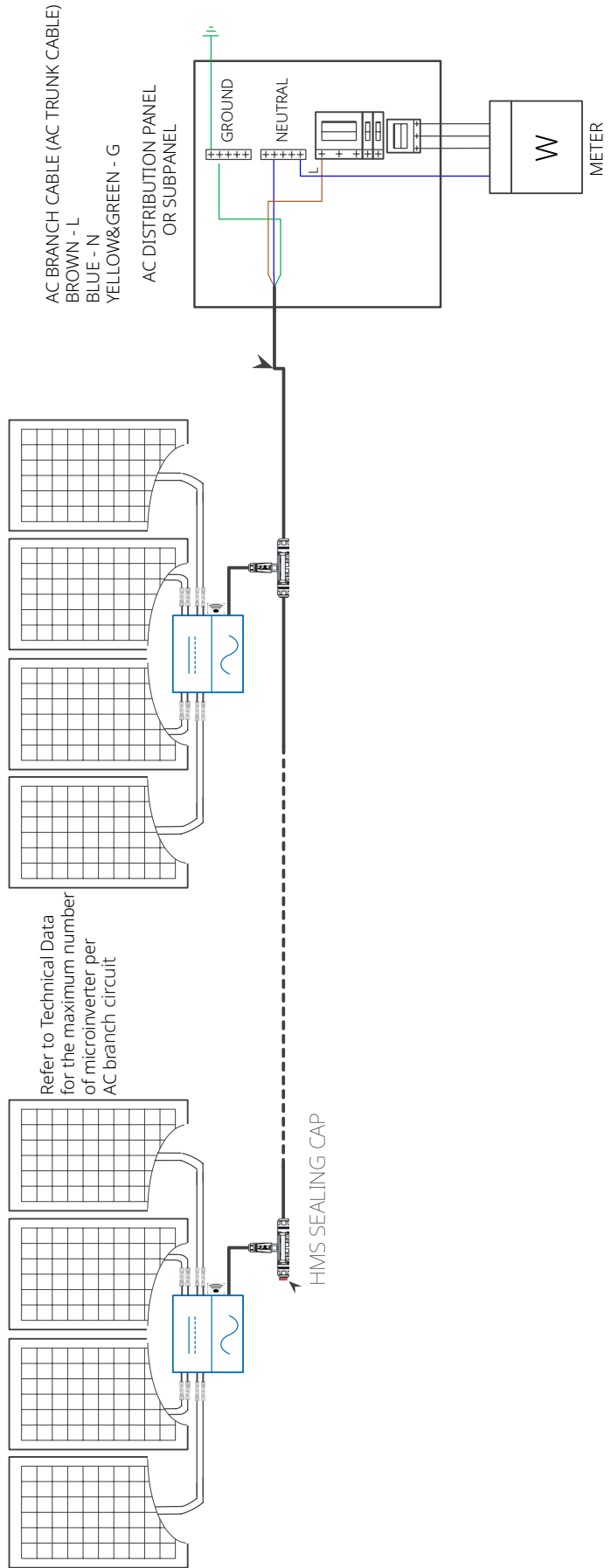

11. Appendix 3: Checklist

Mechanical Installation

Check that:

- The installation location is properly selected.
- The installation location has sufficient free space for ventilation and heat dissipation.
- The microinverters are beneath the PV module to avoid direct exposure to rain, UV, and other harmful weather events.
- The microinverters have been installed on the label side up.
- The microinverters are properly fastened to the installation base and secured to the mounting racking.

Electrical Installation

Check that:

- The AC breakers are functioning properly and have been closed.
- The utility voltage and frequency are within the allowable range (see [Technical Data](#)).
- Unused ports on the first AC Trunk Connector per line have HMS Sealing Caps on.
- The AC power cable connections at L, N, and PE and their tightening torques are OK.

12. Appendix 4: Terms and Abbreviations

A	
AC	alternating current
AP	access point
D	
DC	direct current
M	
MPPT	maximum power point tracking
O	
O&M	operations and maintenance
P	
PE	protective earthing
PPE	personal protective equipment
PV	photovoltaic
S	
SN	serial number